

# OPERATING MANUAL

## Aalborg® DPC

### Digital Mass Flow Controllers

Download the latest version of  
the manual from the product web page:

[Aalborg.com/DPC\\_o/87](http://Aalborg.com/DPC_o/87)



# AALBORG®

20 CORPORATE DRIVE • ORANGEBURG, NY 10962 • PHONE: 845.770.3000 • FAX: 845.770.3010  
e-mail: [info@aalborg.com](mailto:info@aalborg.com) • toll free in usa or canada: 1.800.866.3837 • web site: [www.aalborg.com](http://www.aalborg.com)



## **CAUTION:**

This product is not intended to be used in life support applications!



## **CAUTION:**

K-Factors at best are only an approximation.  
K-Factors should not be used in applications that require accuracy better than +/- 5 to 10%.

*Aalborg*® is a registered trademark of Aalborg® Instruments & Controls.

*NOTE:* Aalborg® reserves the right to change designs and dimensions at its sole Discretion at any time without notice. For certified dimensions please contact Aalborg®.

# TABLE OF CONTENTS

<b>1. Unpacking the DPC Mass Flow Controller</b> .....	1
1.1 Inspect Package for External Damage.....	1
1.2 Unpack the Mass Flow Controller.....	1
1.3 Returning Merchandise for Repair.....	1
<b>2. INSTALLATION</b> .....	1
2.1 Safety Instructions.....	1
2.2 Primary Gas Connections.....	3
2.3 Pressure Requirements.....	3
2.3.1 DPC 07/17/37/47/57/67/77 Pressure Requirements.....	3
2.3.2 DPC04/14 "BREEZE" low differential pressure models.....	4
2.4 Mounting.....	5
<b>3. ELECTRICAL CONNECTIONS</b> .....	5
3.1 Power Supply Connections.....	6
3.2 Analog Set Point Input Signals Connections.....	7
3.3 Analog Output Signals Connections.....	8
3.4 Digital Communication Interface Connections.....	8
<b>4. PRINCIPLE OF OPERATION</b> .....	11
<b>5. SPECIFICATIONS</b> .....	12
5.1 CE Compliance.....	14
5.2 DPC Accessories.....	15
<b>6. OPERATING INSTRUCTIONS</b> .....	18
6.1 Preparation and Power Up.....	18
6.2 Swamping Condition.....	19
6.3 Instrument Process Information (PI) Screens.....	19
6.4 Local User Interface Menu Structure.....	22
6.4.1 Parameter Entry.....	23
6.4.2 Submenu "Change PP Password".....	23
6.4.3 Instrument Set Point and Valve Control.....	24
6.4.4 Submenu "Control PID Parameters".....	26
6.4.5 Submenu "Device Information".....	27
6.4.6 Submenu "Units of Measure".....	28
6.4.7 Submenu "User-Defined Units".....	31
6.4.8 Submenu "Select Gas".....	33
6.4.9 Submenu "User-Defined Mixture".....	39
6.4.10 Submenu "Gas Flow Alarm".....	43
6.4.11 Submenu "Gas Pressure Alarm".....	45
6.4.12 Submenu "Gas Temperature Alarm".....	47
6.4.13 Totalizers Settings.....	49

6.4.14 Submenu “Pulse Output” .....	51
6.4.15 General Settings .....	52
6.4.15.1 Valve Parameters .....	52
6.4.15.2 STP/NTP Conditions .....	52
6.4.15.3 Display and Process Information (PI) Screens .....	53
6.4.15.4 Submenu “Communication Port Settings” .....	55
6.4.15.5 Submenu “Modbus Interface” (optional) .....	57
6.4.15.6 Relay Assignment .....	59
6.4.15.7 Analog Output Configuration .....	60
6.4.15.8 Analog Input Configuration .....	61
6.4.15.9 Status LED Settings .....	62
6.4.15.10 Signal Conditioner Settings .....	64
6.4.15.11 Program Set Point .....	64
6.4.16 Sensor Zero Calibration .....	66
6.4.16.1 DP Sensor Zero Calibration .....	67
6.4.16.2 Start AP Auto Tare .....	68
6.4.17 Submenu “Alarms and Diagnostic” .....	69
6.4.17.1 Alarm Event Register .....	70
6.4.17.2 Diagnostic Events Register .....	74
6.4.17.3 Sensors ADC Reading (read only) .....	77
6.4.17.4 Temperature Sensors Diagnostic (read only) .....	78
6.4.17.5 Analog Output & PO Queue Diagnostic (read only) .....	78
6.4.17.6 Solenoid Valve Parameters Diagnostic (read only) .....	79
6.4.17.7 Reference Voltage & DSP Calculation Diagnostic .....	79
6.5 Multi-Functional Push-Button Operation .....	80
<b>7. MAINTENANCE .....</b>	<b>82</b>
7.1 General .....	82
7.2 Cleaning .....	82
<b>8. RECALIBRATION .....</b>	<b>82</b>
<b>9. RS485/RS232 SOFTWARE INTERFACE COMMANDS .....</b>	<b>83</b>
9.1 General .....	83
9.2 Commands Structure .....	83
<b>10. TROUBLESHOOTING .....</b>	<b>111</b>
10.1 Common Conditions .....	111
10.2 Troubleshooting Guide .....	112
10.3 Technical Assistance .....	115
<b>Appendix I: Component Diagram .....</b>	<b>116</b>
<b>Appendix II: Dimensional Drawings .....</b>	<b>118</b>
<b>Appendix III: Warranty .....</b>	<b>120</b>
<b>Appendix IV: Index of Figures .....</b>	<b>121</b>
<b>Appendix V: Index of Tables .....</b>	<b>123</b>

# 1. UNPACKING THE DPC MASS FLOW METER

## 1.1 Inspect Package for External Damage

Your DPC Mass Flow Controller was carefully packed in a sturdy cardboard carton, with anti-static cushioning materials to withstand shipping shock. Upon receipt, inspect the package for possible external damage. If the unopened package is damaged, contact the shipping company immediately to make a report.

## 1.2 Unpack the Mass Flow Meter

Open the carton carefully from the top and inspect for any sign of concealed shipping damage. In addition to contacting the shipping carrier please forward a copy of any damage report to your distributor or Aalborg® directly.

When unpacking the instrument please make sure that you have all the items indicated on the Packing List. Please report any shortages promptly.

## 1.3 Returning Merchandise for Repair

Please contact the customer service representative of your distributor or Aalborg® if you purchased your Mass Flow Meter directly, and request a **Return Authorization Number (RAN)**. **Equipment returned without an RAN will not be accepted.** Aalborg® reserves the right to charge a fee to the customer for equipment returned under warranty claims if the instruments are tested to be free from warranted defects. Shipping charges are borne by the customer. Meters returned “collect” will not be accepted!

**It is mandatory that any equipment returned for service be purged of any hazardous contents including, but not limited to, toxic, infectious, corrosive or radioactive material. No work shall be performed on a returned product unless the customer submits a fully executed and signed SAFETY CERTIFICATE. Contact the Service Manager at your distributor or at Aalborg to obtain this form prior to returning the product.**

# 2. INSTALLATION

## 2.1 Safety Instructions



Aalborg® warranties and all other responsibilities by direct or implied are voided if users fail to follow all instructions and procedures described in this manual.



**LIFE SUPPORT APPLICATIONS:** The DPC is not designed for use in life support applications where malfunctioning of the device may cause personal injury. Customers using or selling this device for use in such applications do so at their own risk and agree to be fully responsible for any damages resulting from improper use or sale.

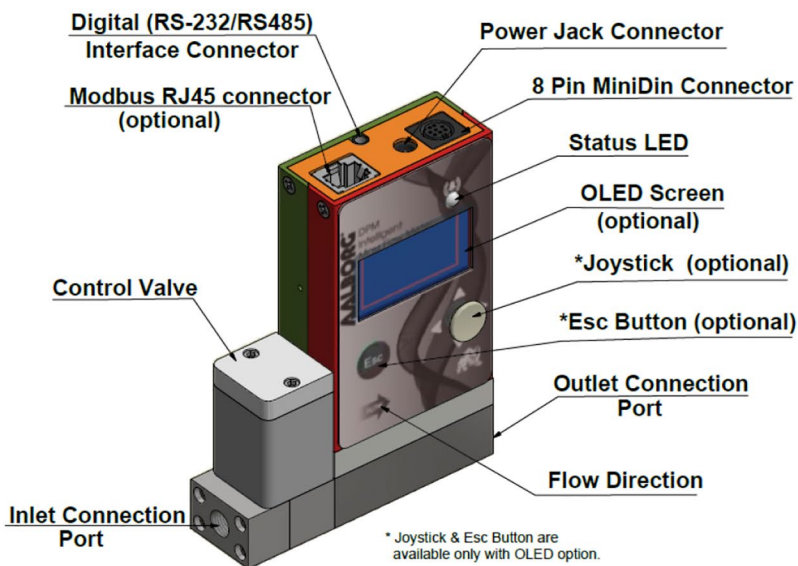

FIGURE 1: DPC Mass Flow Controller shown with an upstream valve configuration

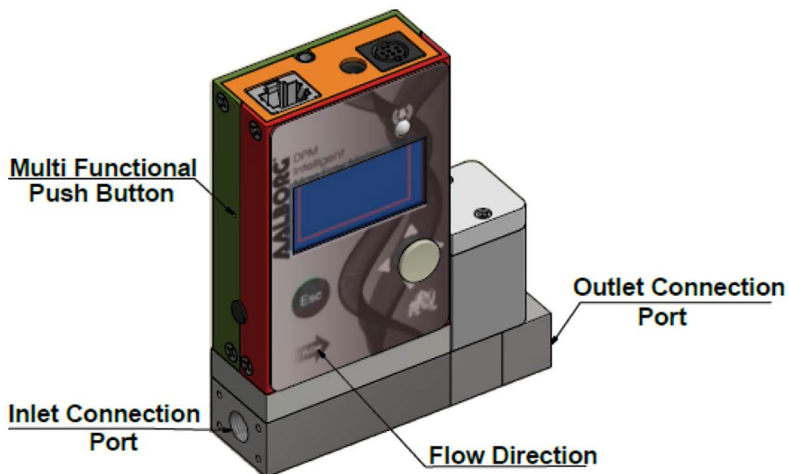

FIGURE 2: DPC Mass Flow Controller shown with a downstream valve configuration



**CAUTION** Some of the IC devices used in the DPC are static-sensitive and may be damaged by improper handling. When adjusting or servicing the device, use of a grounded wrist strap is recommended to prevent inadvertent damage to the integral solid-state circuitry.

## 2.2 Primary Gas Connections

The DFC Mass Flow Controller will not operate with liquids. Only clean, non corrosive gases may be introduced into the instrument. If gases are contaminated, they must be filtered to prevent the introduction of impediments to the sensor.



**CAUTION:** DPC meters should not be used for monitoring oxygen gas unless specifically cleaned and prepared for such application.

For more information, contact your distributor or Aalborg®.

Prior to connecting gas lines, inspect all parts of the piping system, including ferrules and other fittings, for dust or other contaminants. Do not use pipe grease or sealant on process connections as they can contaminate narrow laminar flow elements that may cause permanent damage to the instrument.

When connecting the gas system to be controlled, be sure to observe the direction of gas flow as indicated by the arrow on the front of the instrument.

Insert tubing into the compression fittings until the ends of the properly sized tubing sit flush against the shoulders of the fittings. Compression fittings are to be tightened 1¼ turns according to the manufacturer's instructions. Avoid overtightening which may seriously damage the compression fitting.

## 2.3 Pressure Requirements

### 2.3.1 DPC 07/17/37/47/57/67/77 Pressure Requirements

Maximum operating line (common mode) pressure for DPC07/17/37/47/57/67/77 series flow controllers is 120 PSIG (8.3 Bar). For controllers with downstream valve configuration if the installation line pressure is more than 120 PSIG (8.3 Bar), a pressure regulator must



**CAUTION:** For DPC07/17/37/47/57/67/77 flow controllers, the maximum common mode pressure in the instrument must not exceed 120 PSIG (8.3 bar). Applying pressure above 120 PSIG (8.3 bar) will cause permanent damage to the differential pressure sensor.



**CAUTION:** Do not apply upstream – downstream differential pressure exceeding 12 PSID to DPC07/17/37/47/57/67/77 models of flow controllers when valve is in OPEN mode. Exposure to higher differential pressures may cause permanent damage to the product.

For DPC07/17/37/47/57/67/77 controllers normally high common mode pressure (within 120 PSIG) will not damage the differential pressure sensor, but pressure transients (momentary pressure variations) on upstream or downstream ports can result in permanent sensor damage to the product.

For DPC07/17/37/47/57/67/77 controllers avoid instantaneous application of high differential pressure by switching solenoid valve to OPEN mode while differential pressure across upstream and downstream of the controller is more than 12 PSID.

### **2.3.2 DPC04/14 "BREEZE" low differential pressure models pressure requirements**

Maximum operating line (common mode) pressure for Breeze (low differential pressure) DPC04/14 models of flow controllers is 50 PSIG (3.44 Bar). For controllers with downstream valve configuration if the installation line pressure is more than 50 PSIG (3.44 Bar), a pressure regulator must be installed upstream of the flow controller to bring pressure down to 50 PSIG (3.44 Bar).



**CAUTION:** For Breeze DPC 04/14 series models the maximum common mode pressure in the instrument must not exceed 50 PSIG (3.44 bar). Applying pressure above 50 PSIG (3.44 bar) will cause permanent damage to the differential pressure sensor.

For Breeze DPC04/14 models do not apply upstream – downstream differential pressure exceeding 9.75 PSID when valve is in OPEN mode. Exposure to higher differential pressures may cause permanent damage to the product.

For Breeze DPC04/14 models normally high common mode pressure (within 50 PSIG) will not damage the differential pressure sensor, but pressure transients (momentary pressure variations) on upstream or downstream ports can result in permanent sensor damage to the product.

For Breeze DPC04/14 models avoid instantaneous application of high differential pressure by switching solenoid valve to OPEN mode while differential pressure across upstream and downstream of the controller is more than 9.75 PSID.

The user shall install the instrument only in process lines that meet the DPC controller's pressure and temperature ratings. A margin of safety should be provided if spikes and surges exist in the process. Proper pressure relief valves and burst plates should be installed in high pressure applications.





**CAUTION:** To avoid obstructions and contamination in the sensor tube and the narrow flow channels in the laminar flow element, the user should install the instrument in process lines that have clean gases. Upstream particulate filters with maximum particulate size 20 $\mu$  are recommended for all applications.

## 2.4 Mounting

DPC04/07/14/17/37/47/57/66/77 series Mass Flow Controllers have mounting holes with 6-32 thread (8-32 thread for DPC 57/67/77) on the bottom of the instrument body for mounting to flat panels. See APPENDIX II for exact dimensions.

The DPC Mass Flow Controller can be mounted in any position. It is not required to maintain straight runs of pipe upstream or downstream of the instrument. It is preferable to install the controller in a stable environment, free of frequent and sudden temperature changes, high moisture, and drafts.

DPC controller ports are equipped with 10-32 female thread (DPC04/07), 1/8" NPT female thread (DPC14/17/37), 1/4" NPT female thread (DPC47), 1/2" NPT female thread (DPC57) and 3/4" NPT female thread (DPC67/77).

## 3. Electrical Connections

DPC instrument is equipped with an 8 pin-MiniDIN power, analog/relay output, interface connector. Table I explains the pin designations. See **Figure 3** for a Pin Diagram.

**TABLE I: 8-PIN DESIGNATIONS AND NOTES**

PIN	FUNCTION	NOTE
1	Solid State SPST Relay NO (normally open) contact #1	Do not exceed SSR maximum voltage 48 AC peak/DC and maximum load current 400 mA.
2	Solid State SPST Relay NO (normally open) contact #2	
3	Analog Set Point Input (+) (0-5Vdc, 0-10Vdc, 4-20mA)	Input Impedance: 100K (0-5, 0-10 Vdc) 250 Ohm (4-20 mA)
4	Analog (0-5Vdc, 0-10Vdc, 4-20 mA) Input/Output reference (-)	Common (return) for pins 3 and 6 (0-5Vdc or 0-10 Vdc or 4-20 mA)
5	Not Assigned. Do Not Connect!	<b>Factory use only. Do Not Connect any signals to this pin!</b>
6	Analog (0-5Vdc, 0-10Vdc or 4-20 mA) Output (+)	Output. Do not apply external voltage or any current source. Be sure to observe recommended load impedance.
7	Power supply, positive (+)	Power input 12 – 26 Vdc. (DPC04/07/14/17/37/47) or 24-26Vdc (DPC57/67/77).
8	Power supply, common (-)	Power input common.



**CAUTION:** 4-20 mA analog output requires at least 14 Vdc power.

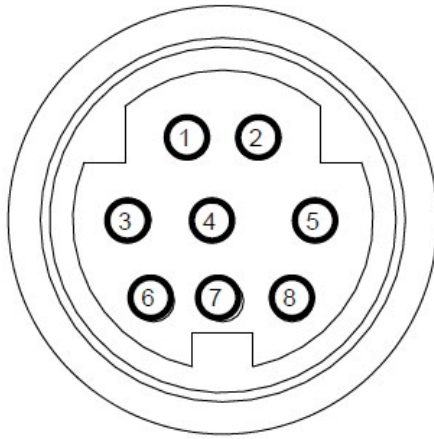

**Figure 3:** DPC 8-pin mini-din connector configuration



**CAUTION:** Generally, "Mini-DIN" Connector numbering patterns are standardized. There are, however, some connectors with nonconforming patterns, so the numbering sequence on your mating connector may or may not coincide with that shown in our pin configuration above. It is imperative that you match the appropriate wires in accordance with the correct sequence regardless of the particular numbers displayed on the mating connector.

### 3.1 Power Supply Connections

The AC to DC power supply requirements for DPC04/07/14/17/37/47 controllers are 12 to 26 Vdc, with maximum load current at least 350 mA (unipolar power supply), and maximum ripple below 150 mV P-P. The AC to DC power supply requirements for DPC57/67/77 controllers are 24 to 26 Vdc, with maximum load current at least 650 mA (unipolar power supply), and maximum ripple below 150 mV P-P.

Power can be applied to the DPC controller either through the power jack or the 8-pin Mini-DIN connector (see **Figure 1**).



**CAUTION:** Never apply power simultaneously from both connectors, as this may damage the instrument.

DC Power (+) ----- pin 7 of the 8-pin Mini-DIN connector

DC Power (-) ----- pin 8 of the 8-pin Mini-DIN connector



**CAUTION:** Never apply power voltage above 26Vdc. Doing so may damage the DPC and/or cause faulty operation.



**CAUTION:** Make sure power is OFF when connecting or disconnecting any cables or wires to or from the system.



**NOTE:** The (+) and (-) power inputs are each protected by a 300mA (DPC04/07/14/17/27/47) and 750mA (DPC57/67/77) (medium time-lag) resettable fuse. If a shorting condition or polarity reversal occurs, the fuse will cut power to the flow controller circuit: disconnect the power to the instrument, correct the faulty condition, and reconnect the power. The fuse will reset once the faulty condition has been corrected.

### 3.2 Analog Set Point Signals Connections



**CAUTION:** When connecting the source signals to the input terminals, do not exceed the rated values shown in the specifications (see Section 5). Failure to do so might cause damage to this device or signal source equipment. Be sure to check if the wiring and the polarity of the power supply are correct before turning the power ON. Wiring error may cause damage or faulty operation.

DPC series Mass Flow Controllers are equipped with calibrated 0-5Vdc, 0-10Vdc or 4-20 mA set point input signals. These linear input signals represents 0-100% of the flow controller's full scale range. The user may select the desired input analog interface type using a local OLED/Joystick interface or via digital communication interface.

For 0-5 VDC, 0-10 VDC or 4-20 mA input signal connection:

External Input Plus (+) ----- pin 3 of the 8-pin Mini-DIN connector  
External Input Minus (-) ----- pin 4 of the 8-pin Mini-DIN connector



**NOTE:** The **Analog** interface source must be selected (see Section 6.4.15.8), in order to control flow rate via analog input signal connections.



**CAUTION:** If nothing is connected to Pin 3, and the controller's set point source is set for analog control, the instrument may generate random flow rate values. When 0-5 or 0-10 Vdc input signals are selected as the source of the set point, make sure Pin 3 is driven by low impedance source of the voltage.

**Do not apply to Pin 3 voltages above 12 Vdc. Doing so will damage input circuitry. Do not connect instrument input to "loop powered" signal sources, as they usually powered with power supplies above 12 Vdc and will damage instrument.**

When 0-5 or 0-10 Vdc input is selected the instrument input impedance is about 100 KOhm. When 4-20 mA input is selected the instrument is functioning as current sink device with input impedance about 250 Ohm.

### 3.3 Analog Output Signals Connections



**CAUTION:** When connecting the load to the output terminals, do not exceed the rated values shown in the specifications (see Section 5). Failure to do so might cause damage to this device. Be sure to check if the wiring and the polarity of the power supply are correct before turning the power ON. Wiring error may cause damage or faulty operation.

DPC series Mass Flow Controllers are equipped with calibrated 0-5Vdc, 0-10Vdc or 4-20 mA output signals. This linear output signal represents 0-100% of the flow controller's full scale range. The user may select the desired analog output interface type using a local OLED/Joystick interface or via digital communication interface.



**CAUTION:** The 4-20 mA current loop output is self-powered (nonisolated, sourcing type). Do not connect an external voltage source (for example, current loop powered systems) to the output signals.

For 0-5 VDC, 0-10 VDC or 4-20 mA output signal connection:

External load Plus (+) ----- pin 6 of the 8-pin Mini-DIN connector

External load Minus (-)----- pin 4 of the 8-pin Mini-DIN connector



**CAUTION:** When connecting the load to the output terminals, always check actual analog output interface configuration. Connecting low impedance (< 5K  $\Omega$ ) loads to the 0-5Vdc or 0-10 Vdc output may cause damage to or faulty operation of the electronics circuitry.



**NOTE:** 4-20 mA analog output requires at least 14 Vdc power input.



**CAUTION:** When connecting the load to the output terminals, always check actual analog output interface configuration. Connecting high impedance (> 500  $\Omega$ ) loads to the 4-20 mA output may cause non linear or faulty operation of the electronics circuitry.

To eliminate the possibility of noise interference, it is recommended that you use a separate cable entry for the DC power, digital communication interface, and analog input/output interface signal lines.

### 3.4 Digital Communication Interface Connections

The digital interface operates via RS-232 or RS-485 (user-selected) and provides access to all applicable internal configuration parameters and data.



**CAUTION:** Before proceeding with communication interface connection, verify the controller's actual communication interface type. For devices with OLED display, the interface type will be briefly (for about 2 seconds) displayed on the banner screen when power is applied. If your instrument does not have a display, the communication interface type can be identified by briefly pressing the multi-function button and monitoring status LED response (see Section 6.5).

Communication Settings for RS-232/RS-485 communication interface The default baud rate is 9600 baud (user-selected; see Section 5, Specifications).

Stop bit:	.....	1
Data bits:	.....	8
Parity:	.....	None
Flow Control:	.....	None

### RS-232 Communication Interface Connection

Crossover connection must be established:

HOST PC RS-232 RX (pin 2 on the host PC DB9 connector)	-----	Controller (RS-232 TX) pin 3 (Ring) of the 3-pin stereo jack connector (TX+)
HOST PC RS-232 TX (pin 3 on the host PC DB9 connector)	-----	Controller (RS-232 RX) pin 2 (Tip) of the 3-pin stereo jack connector (RX-)
HOST PC RS-232 SIGNAL GND (pin 5 on the host PC DB9 connector)	-----	Controller (Digital GND) pin 1 (Sleeve) of the 3-pin stereo jack connector

Each DPC ordered with RS-232 interface option is supplied with default crossover 1.5- foot long communication cable (AALBORG P/N: CBL-A232) DB9 female to stereo 3.5 mm Plug.

If custom length cable is required, it can be assembled using the connection diagram shown in **Figure 4**.

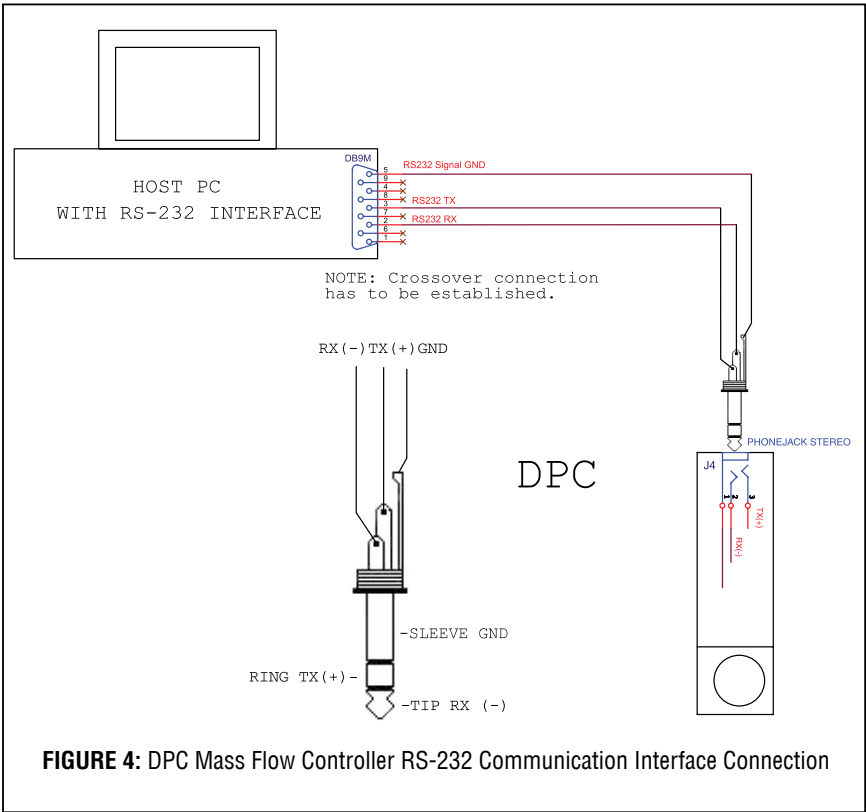

### RS-485 Communication Interface Connection

The RS-485 converter/adaptor must be configured for: multidrop, 2-wire, half duplex mode (see Figure 5). The transmitter circuit must be enabled by TD or RTS (depending on which is available on the converter/adaptor). Settings for the receiver circuit should follow the selection made for the transmitter circuit in order to eliminate echo.

- RS-485 A line T(-) or R(-) ----- pin 2 on 3-pin Audio-connector, middle section or "tip" DPC (RX-), (WHITE wire)
- RS-485 B line T(+) or R(+) ----- pin 3 on 3-pins Audio-connector, the "ring" section DPC (TX+), (RED wire)
- RS-485 GND (if available) ----- pin 1 on 3-pin Audio-connector, the "sleeve" section DPC (GND), (Shield wire)

Each DPC ordered with RS-485 interface option is supplied with a default 3-foot length of communication cable (AALBORG P/N: CBL- A485DP) Stereo 3.5 mm plug to stripped wires.

If custom length cable is required, it can be assembled using the connection diagram shown in **Figure 5**:

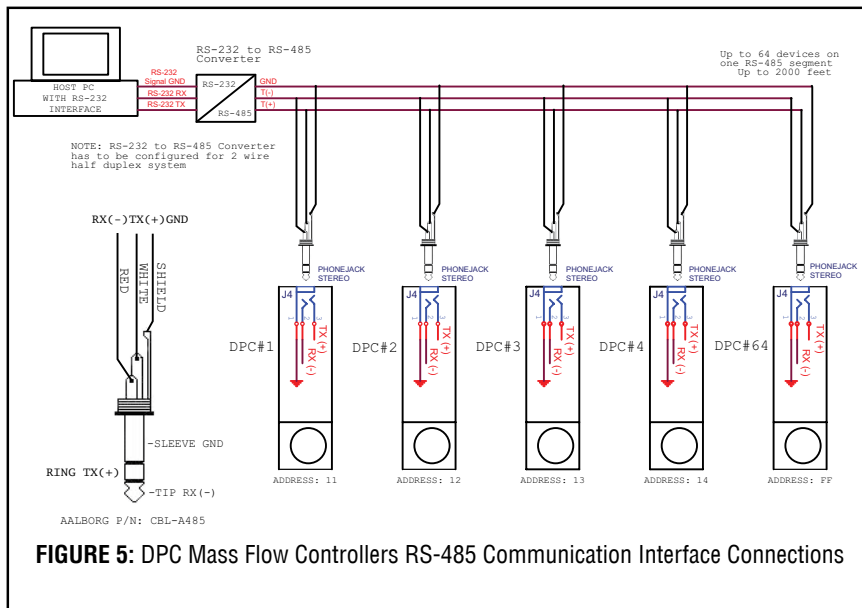

When the DPC device is set as the last device on the long RS-485 bus segment, the 120  $\Omega$  bus termination resistor must be connected between the RS-485 (+) and (-) terminals close (< 6 feet) to this device.



**CAUTION:** The DPC instrument offers an integrated switchable 120 $\Omega$  termination resistor between the RS-485 (+) and (-) pins. On instruments with a local display and joystick interface, the 120 $\Omega$  termination resistor can be activated (enabled) using General Settings / Communication Port / RS-485 Termination menu selection. By default, the instrument is shipped from the factory with the RS-485 Termination mode set to Disabled.

#### 4. PRINCIPLE OF OPERATION

The DPC flow controllers are based on the measurement of the differential pressure across specially designed restrictor flow elements. The restrictor flow element is designed to establish laminar flow across the entire range of the instrument's operation from 0 to 133% of full scale range. A high accuracy and high resolution differential pressure sensor is utilized to measure pressure drop across laminar flow channel, which is linearly proportional to volumetric flow rate. To convert volumetric flow in to the mass flow, high accuracy and high resolution absolute pressure and temperature sensors are utilized.

Based on data from the sensors and Gas Properties from the built-in data base of the instrument, the micro-controller calculates Volumetric and Mass Flow, which along with Pressure and Temperature parameters are available on the instrument display or via digital interfaces. In addition, the Mass Flow reading is accessible via the instrument Analog interface which can be set by user to 0-5, 0-10 Vdc or 4-20mA mode.

The DPC flow controller supports multi-gas functionality which allows users on site to select the desired measured gas using local Display/Joystick interface or digital communication interface. See Tables X - XVIII which provide lists of supported gases.

The set point can be controlled from one of the four user selectable sources: analog, local OLED/Joystick interface, Digital Communication Interface (RS-232/RS-485, or optional Modbus), Programmable Table.

The DPC flow controller can display flow rate in 43 different mass flow or 15 different volumetric flow engineering units. Instrument parameters and functions can be programmed locally via optional OLED/Joystick interface or remotely via the RS-232/RS-485 interface or optional Modbus RTU interface. DPC flow controllers support various functions including two programmable flow totalizers; low, high or range flow; temperature and pressure alarms; automatic zero adjustment (activated via local or digital communication interface); programmable solid state relay (SSR); programmable 0-5 Vdc, 0-10 Vdc or 4-20 mA analog inputs and outputs; user-programmable pulse output (via SSR); and self-diagnostic alarms.

Optional local OLED readout with adjustable brightness level provides mass and volumetric flow rate, total volume reading in currently selected engineering units, and diagnostic events and indication.

## **5. SPECIFICATIONS**

<b>FLOW MEDIUM:</b>	Please note that DPC Mass Flow Controllers are designed to work only with clean gases, never any corrosive gas and never any liquid.
<b>CALIBRATIONS:</b>	Performed at standard conditions (14.7 psia [101.4 kPa] and 70 °F [21.1 °C]) unless otherwise requested or stated.
<b>ENVIRONMENTAL (PER IEC 664):</b>	Installation Level II; Pollution Degree II.
<b>FLOW ACCURACY (INCLUDING LINEARITY):</b>	$\pm(0.5\% \text{ RD} + 0.2\% \text{ FS})$ at calibration temperature and pressure conditions after tare.
<b>REPEATABILITY:</b>	$\pm 0.2\%$ of full scale.
<b>FLOW TEMPERATURE COEFFICIENT:</b>	0.05% of full scale/°C or better.
<b>FLOW PRESSURE COEFFICIENT:</b>	0.01% of full scale/psi (6.895 kPa) or better.
<b>TYPICAL FLOW RESPONSE TIME:</b>	Default 150 ms (adjustable) <sup>1</sup> .
<b>INSTRUMENT WARM-UP TIME:</b>	< 5 seconds.
<b>MAXIMUM CONTROLLABLE FLOW RANGE:</b>	125% Full Scale.
<b>OPERATION RANGE/TURNDOWN RATIO:</b>	0.5% to 100% Full Scale / 200:1.



**MASS REFERENCE CONDITIONS (STP):**

70 °F & 14.696 PSIA  
(other references available on request).

**MAXIMUM INTERNAL GAS PRESSURE (STATIC):**

DPC07/17/37/47/57/67/77: 120 PSIG.  
DPC04/14: 50 PSIG.

**MAXIMUM INSTANTANEOUS DIFFERENTIAL PRESSURE ACROSS DIFFERENTIAL PRESSURE SENSOR:**

DPC07/17/37/47/57/67/77: 12 PSID.  
DPC04/14: 9.75 PSID

**PROOF PRESSURE:**

DPC07/17/37/47/57/67/77: 145 PSIG.  
DPC04/14: 50 PSIG.

**VALVE TYPE:**

Normally Closed.

**VALVE MAXIMUM OPERATING PRESSURE (WITH UPSTREAM CONFIGURATION):**

DPC04/07/14/17: (< 2 sL/min) - 150 PSIG  
DPC17: (2 ÷ 5 sL/min) - 100 PSIG  
DPC17: (5 ÷ 20 sL/min) - 50 PSIG  
DPC37/47: 50 PSIG  
DPC57/67/77: 50 PSIG

**OPERATING TEMPERATURE:** -10 to +60 °C (14 to 140 °F).

**MOUNTING ATTITUDE SENSITIVITY:**

DPC04/07/14/17/37/47 None.  
DPC57/67/77 Mount with cylinder  
vertical and upright position.

**RELATIVE GAS HUMIDITY RANGE:**

0 to 100% (Non-Condensing).

**INGRESS PROTECTION:**

IP40.

**LEAK INTEGRITY:**

1 x 10<sup>-9</sup> sccs He max to the outside environment.

**OUTPUT SIGNALS:**

Linear 0-5 Vdc (3000 Ω min. load impedance);  
Linear 0-10 Vdc (5000 Ω min. load impedance);  
Linear 4-20 mA (550 Ω maximum loop resistance).  
Maximum noise 10mV peak to peak (for 0-5/0-10 Vdc output).

**SET POINT INPUT SIGNALS:**

Linear 0-5 Vdc (100 K Ω Input impedance);  
Linear 0-10 Vdc (100 KΩ input impedance);  
Linear 4-20 mA ( 250 Ω input impedance)

Circuit boards have built-in polarity reversal protection, and a 300mA (DPC04/07/14/17) or 750 mA (DPC57/67/77) resettable fuse provides power input protection.

**DIGITAL OUTPUT SIGNALS:** Standard RS-232 or RS-485 (user-selected). Optional Mod bus over isolated RS-485 transceiver.

**WETTED MATERIALS:** Stainless steel, FKM O-rings, high temperature polyamide, alumina ceramic, epoxy, silicone, glass, gold, C36000 brass.



**CAUTION:** Aalborg® makes no expressed or implied guarantees of corrosion resistance of mass flow controllers as pertains to different flow media reacting with any components of the controllers. It is solely the customer's responsibility to select the model best suited for a particular gas, based on the fluid contacting (wetted) materials offered in the different models.

**INLET AND OUTLET CONNECTIONS:**

DPC04/07 10-32 female thread, DPC14/17/37 1/8" NPT female thread, DPC47 1/4" NPT female thread, DPC57 1/2" NPT female thread, DPC67/77 3/4" NPT female thread for user-supplied fittings.

**DISPLAY:** Optional 128 x 64 pixels graphic yellow OLED with **Esc** button and Joystick interface. Simultaneously displays: Mass Flow, Totalizer Volume, Pressure and Temperature or Mass Flow, Volumetric Flow, Pressure and Temperature (user-selectable screens).

For DPC with full scale 20 sml/min and lower or above 100 sl/min the response time may be slightly longer.

## **5.1 CE Compliance**

EMC Compliance with 2014/30/EU as amended. CISPR11.

Emission Standard: EN61000-6-3, Group 1, Class A.

Immunity Standard: EN61000-6-1, IEC EN 61000-4-2, IEC EN 61000-4-3.

**TABLE II: DPC FLOW RANGES**

MODEL NO.	FULL SCALE MASS FLOW RATE	PRESSURE DROP AT FULL SCALE FLOW (PSID)	PROCESS CONNECTION
DPC07	0.5 to 50 sml/min	1.25	10-32 female thread
DPC17	51 sml/min to 20 sl/min	25.0	1/8" NPT female
DPC37	21 sl/min to 50 sl/min	9.0	1/8" NPT female
DPC47	51 sl/min to 100 sl/min	15.0	1/4" NPT Female
DPC57	250 sL/min	2.5	1/2" NPT Female
DPC67	500 sL/min	6.9	3/4" NPT Female
DPC77	1000 sL/min	15.0	3/4" NPT Female
DPC (BREEZE™) LOW PRESSURE DROP [AIR]			
DPC04	0.5 smL/min to 20 smL/min	0.08	10-32 female thread
DPC14	21 smL/min to 2 sL/min	0.19	1/8" NPT Female

**5.2 DPC Accessories****TABLE III: DPC ACCESSORIES**

FITTINGS		
MODEL NO.	FITTING CODE	DESCRIPTION
DPC 04/07	F1C5	10-32 Thread, 1/8 Tubing, Compression, 316 ss
DPC 04/07	F2C5	10-32 Thread, 1/8 Tubing, Compression, Nickle Plated Brass
DPC 14/17	F2C2	1/8" NPT Thread, 1/8 tubing, Compression, 316 ss.
DPC 14/17	F2C4	1/8" NPT Thread, 1/4 tubing, Compression, 316 ss.
DPC 37	F4C4	1/4" NPT Thread, 1/4 Tubing, Compression, 316 ss.
DPC 47	F4C6	1/4" NPT Thread, 3/8 tubing, Compression, 316 ss.
DPC 57	F8C6	1/2" NPT Thread, 3/8 tubing, Compression, 300 series ss.
DPC 67	F8C8	1/2" NPT Thread, 1/2 tubing, Compression, 300 series ss.
DPC 77	1210-1-12-316	3/4" NPT Thread, 3/4 tubing, Compression, 300 series ss.

<b>POWER SUPPLIES</b>	
<b>PS-GFM-110NA-2</b>	Power Supply, 110 V / 12 Vdc / North America
<b>PS-GFM-110NA-4</b>	Power Supply, 110 V / 24 Vdc / North America
<b>PS-GFM-230EU-2</b>	Power Supply, 220 V / 12 Vdc /Europe
<b>PS-GFM-230EU-4</b>	Power Supply, 220 V / 24Vdc /Europe
<b>PS-GFM-240UK-2</b>	Power Supply 240 V / 12 Vdc /United Kingdom

<b>CABLES</b>	
<b>CBL-A232</b>	Communication Cable for DPC with RS-232 Interface 1.5 FT 3.5mm stereo audio connector with 3-wire to 9-pin female D-connector (included with each DPC ordered with RS-232).
<b>CBL-A485DP</b>	Communication Cable for DPC with RS-485 Interface 3 FT 3.5mm stereo audio connector with 3-wire to stripped ends.
<b>CBL-8MINIDIN-3</b>	Shielded cable 8-pin Min-DIN with stripped ends 3 feet long
<b>CBL-8MINIDIN-12</b>	Shielded cable 8-pin Min-DIN with stripped ends 12 feet long
<b>COMMUNICATION PORT ACCESSORIES</b>	
<b>USB-RS232</b>	USB to RS-232 converter
<b>USB-RS485</b>	USB to RS-485 converter

<b>MODBUS INTERFACE ACCESSORIES</b>	
<b>ECS803-1</b>	RJ45 shielded Y-adapter (Passive TAP).
<b>TDG1026-8C</b>	RJ45 Modular Coupler.
<b>MOD27T</b>	RJ45 Line Terminator (100 $\Omega$ 0.25 W).
<b>JMOD4S-1</b>	RJ45 Splitter fully shielded (5xRJ45, 1 input 4 outputs).
<b>TRD815BL-2</b>	Category 5E Patch Twisted Pair Cable, RJ45 / RJ45, Blue 2.0 feet.
<b>TRD815BL-10</b>	Category 5E Patch Twisted Pair Cable, RJ45 / RJ45, Blue 10.0 feet.
<b>TRD815BL-25</b>	Category 5E Patch Twisted Pair Cable, RJ45 / RJ45, Blue 25.0 feet.
<b>TRD815BL-10</b>	Category 5E Patch Twisted Pair Cable, RJ45 / RJ45, Blue 10.0 feet.
<b>TRD815BL-25</b>	Category 5E Patch Twisted Pair Cable, RJ45 / RJ45, Blue 25.0 feet

**TABLE IV: PRESSURE DROPS**

MODEL NO.	FLOW RATE [std liters/min]	MAXIMUM PRESSURE DROP		
		[mm H2O]	[psid]	[kPa]
DPC 07	up to 0.05	879	1.25	8.618
DPC 17	1.0	1758	2.5	17.237
DPC 17	2.0	2109	3.0	20.684
DPC 17	5.0	5273	7.5	51.711
DPC 17	10.0	12304	17.5	120.66
DPC 17	20.0	17577	25.0	172.369
DPC 37	30.0	5273	7.5	51.711
DPC 37	50.0	6328	9.0	60.053
DPC 47	80.0	9491	13.5	93.079
DPC 47	100.0	10546	15.0	103.421
DPC57	250	1758	2.5	17.237
DPC67	500	4851	6.9	47.57
DPC77	1000	10546	15.0	103.4
<b>DPC (BREEZE) LOW PRESSURE DROP [AIR]</b>				
DPC04	0.02	56.2	0.08	0.55
DPC14	2	133.6	0.19	1.31

**TABLE V: APPROXIMATE WEIGHTS**

MODEL	WEIGHT	SHIPPING WEIGHT
<b>DPC04/07/14/17</b>	1.40 lbs. (0.635 kg)	3.31 lbs. (1.5 kg)
<b>DPC37/47</b>	1.66 lbs (0.755 kg)	3.66 lbs (1.66 kg)
<b>DPC57</b>	10.0 lbs (4.53 kg)	12.5 lbs (5.7 kg)
<b>DPC67</b>	10.5 lbs (4.76 kg)	13.0 lbs (5.9 kg)
<b>DPC77</b>	11.5 lbs (5.22 kg)	14.0 lbs (6.35 kg)

## 6. OPERATING INSTRUCTIONS

### 6.1 Preperation and Power Up

Initially, after the power is first turned on, the Banner Screen is shown for 2 seconds (see **Figure 6**), then device firmware and EEPROM database revisions will be displayed on the first line, communication interface type and hexadecimal address value on the second line, Communication Port baud rate on the third line, and Modbus hardware status and decimal address value on the fourth line (see Figure 5). These are shown for another 2 seconds. Subsequently, the actual process information (PI) is displayed.

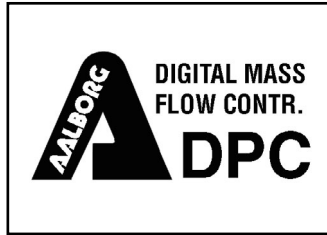

**Figure 6:** DPC first Banner Screen

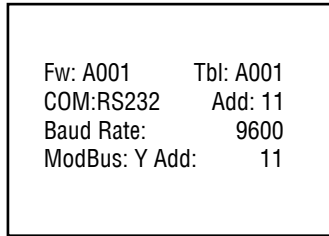

**Figure 7:** DPC Firmware and Communication Interface Information Screen

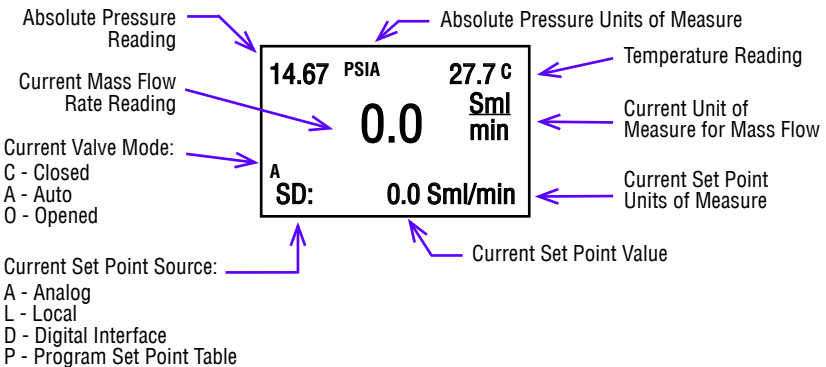

**Figure 8:** DPC INITIAL PROCESS INFORMATION SCREEN



NOTE: Actual content of the OLED screen may vary depending on the model and device configuration.

The main DPC flow controller screen shows current instrument Absolute Pressure, Temperature, Mass Flow reading, Set Point Value, Set Point Source and Valve Mode.



NOTE: 5 seconds after the initial powering of the DPC controller, the status LED will emit a constant GREEN light (normal operation, ready to control).

By default, unless “**Local Set Point Auto Start**” parameter is enabled (see **Section 6.4.3**), after power is applied to the instrument the controller’s **Valve Mode** set to “**Closed**”. In this mode regardless of the “**Set Point Source**” and “**Set Point Value**” parameters settings, the valve will be closed and flow rate through the instrument will be zero.



NOTE: On power up, the last used **Set Point** Source settings will be retrieved from the instrument’s non-volatile memory and set as active.

## 6.2 Swamping Condition

If a flow of more than 133% the nominal maximum flow rate of the Mass Flow Controller is taking place (displayed mass flow reading is flashing), a condition known as "swamping" may occur. Readings of a "swamped" instrument cannot be assumed to be either accurate or linear. Flow must be restored to below 133% of full scale range. Once flow rates are lowered to within calibrated range, the swamping condition will end.

## 6.3 Instrument Process Information (PI) screens

Based on instrument configuration, different parameters may be displayed in the Process Information (PI) screen by moving the control joystick (see **Figure 9**) **Up or Down (DN)**.

Process Information screens can be configured to be static or dynamic (see **Section 6.4.15.3** “**Display and Process Information (PI) Screens**”). Using PI Screen Mask settings, the user can enable (unmask) or disable (mask) up to 8 different process information combinations.

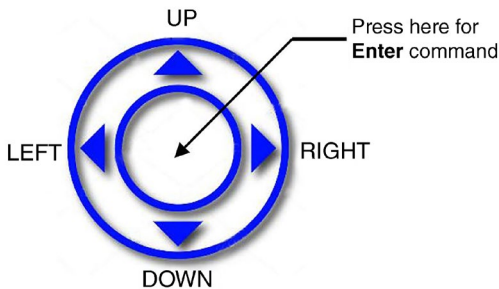
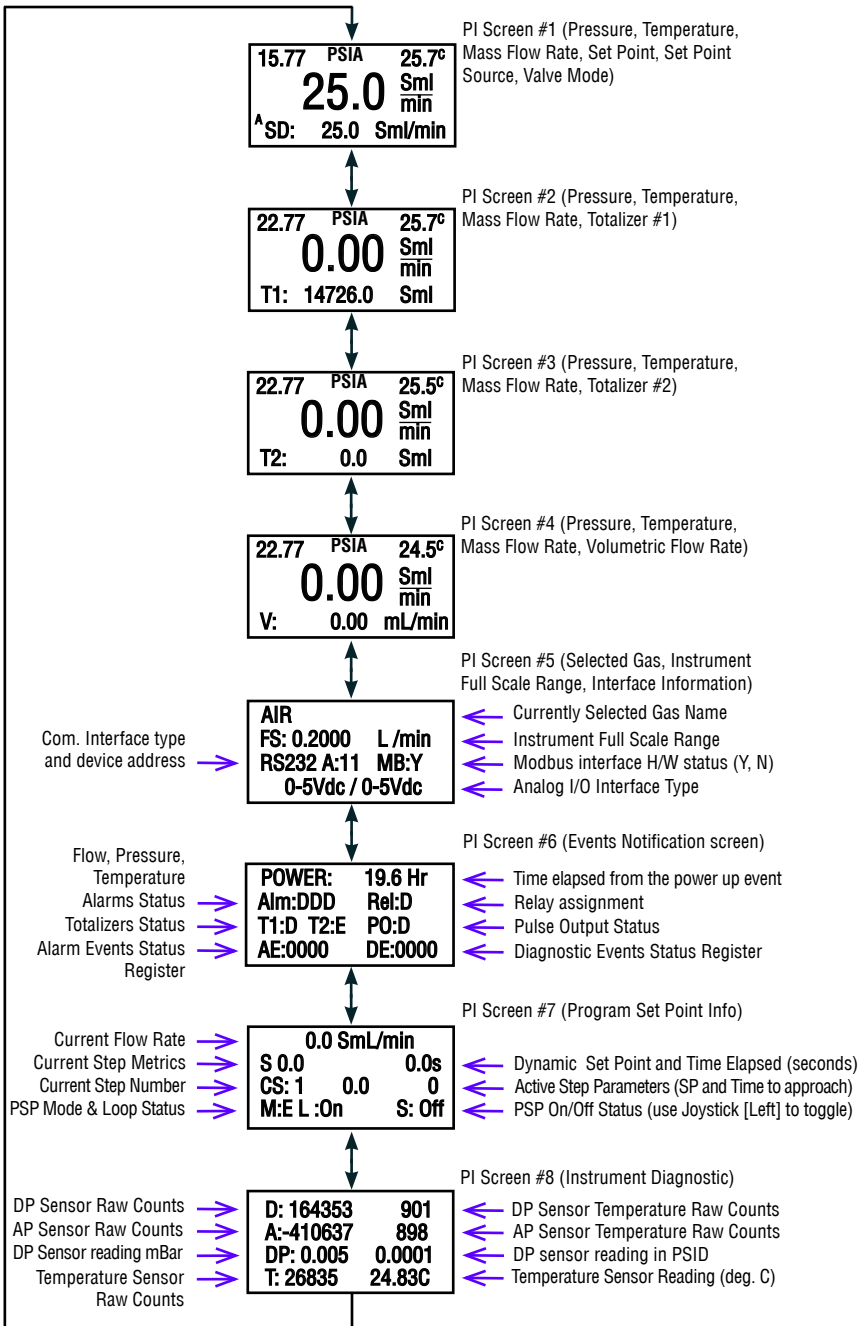

**FIGURE 9:** Control Joystick

sequencing with user-adjusted screen Cycle Time (see Section **6.4.15.3 “Display and Process Information (PI) Screens”**). When the last PI screen is reached, the firmware “wraps around” and scrolls to the initial PI screen once again.

In the Static Mode, moving the joystick **Up** pages through the PI screens in the forward direction, while moving the joystick **DN** pages through the PI screens in the reverse direction. When the last PI screen is reached, the firmware “wraps around” and scrolls to the initial PI screen once again.





**FIGURE 10: DPC PROCESS INFORMATION SCREENS**

## 6.4 Local User Interface Menu Structure

The diagram in Figure 19 gives a general overview of the standard top-level display menu structure (when running firmware version A001). The Esc push-button is used to toggle between the Process Mode (PI screens) and the Setup menus, and to return to upper menu level.

In order to move through the menu items, the user must move the joystick **UP** and **DN**. When the last item in the menu is reached, the menu “wraps around” and scrolls back to the beginning of the menu items list. Similarly, when the first menu item is highlighted and the joystick is moved UP, the menu “wraps around” and scrolls down to the end of the menu item’s list. In order to select the desired menu item, the user must press the joystick down toward instrument front panel (this action is equivalent to the **Enter** button). To go back to upper menu level, the user must press the **Esc** button.

All process configuration parameter settings are password-protected. In order to access or change them, Program Protection (PP) should be disabled. Each time the device is powered up, the Program Protection is enabled automatically. By default, the device is shipped from the factory with the Program Protection (PP) password set to Zero (PP Disabled). If the PP password is set to Zero (Disabled), entering a PP password is not required. A subsequent screen will appear and the Program Protection menu item will be selected:

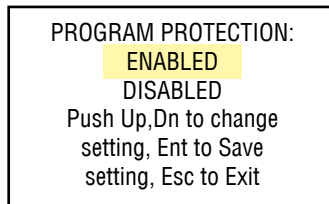

**Figure 11:** Program Protection Screen

Moving the joystick **DN** to select the Disabled option and then pushing the joystick (**ENT**) to save settings will disable program protection.

If the PP password is set to any value more than Zero, the firmware will prompt with “**Enter Program Protection Password**” (see Figure 12).

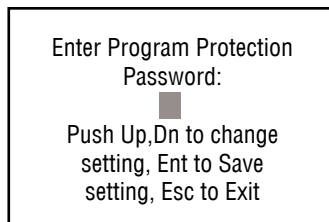

**Figure 12:** Program Protection Password Screen

The user must enter up to 3 digits for the program protection code, in order to be able to access password protected menus.



**NOTE:** By default, the device is shipped from the factory with the Program Protection (PP) password set to Zero (PP Disabled).

Once the correct password is entered, the Program Protection is turned off until the unit is powered up again.

### 6.4.1 Parameter Entry

There are two methods of data entry:

- Direct numerical entry.
- Tabular Input from a menu.

If the menu with direct numerical entry is selected, move the joystick **UP** or **DN** to increase or decrease digit value between 0-9. Move the joystick **RIGHT** or **LEFT** to move the cursor to another digit position. When the desired value is entered, use joystick equivalent of an **ENT** button to accept (to be saved in the EEPROM) the new value.



**NOTE:** During data entry, the input values are checked for acceptability. If data is not acceptable, it is rejected and a message is generated to indicate that the new data has not been accepted.

If the menu with tabular entry is selected, the available menu options can be set using the joystick **UP** and **DN** positions and are accepted by pressing the joystick equivalent of an **ENT** button.

### 6.4.2 Submenu "Change PP Password"

In order to get access to "**Change Program Protection (PP) Password**" menu, Program Protection must be disabled. If PP password is set to Zero (Disabled), entering PP Password is not required and PP can be disabled from "**Program Protection**" menu (see **Figure 11**). If PP Password is set to any value more than Zero, the firmware will prompt with "**Enter Program Protection Password**" (see **Figure 12**). The user must enter a program protection code (up to 3 digits). If the PP password is lost or forgotten, contact the factory or your distributor.

Once the "**Change PP Password**" menu is selected, the following screen will appear.

Old PP Password: ■

New PP Password:

Enter Old PP Password

**Figure 13:** Change PP Password Screen

In order to protect device configuration parameters when changing the PP password, the old PP password must first be entered.

Once old and new passwords are entered, the firmware will prompt with a confirmation message (see **Figure 14**) that the new password has been saved:

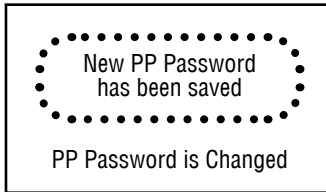

Figure 14: PP Password Change Confirmation Screen

### 6.4.3 Instrument Set Point and Valve Control

In order to be able to change the **Set Point** value via Local OLED/Joystick interface the “**Set Point Source**” parameter must be set to “**Local**”. To do so, from the instrument main PI screens press **Esc** button then using Joystick UP or DN controls navigate to “**General Settings**” menu selection and press ENT. A subsequent screen (Figure 15) will appear and the “**General Settings**” menu items will be listed.

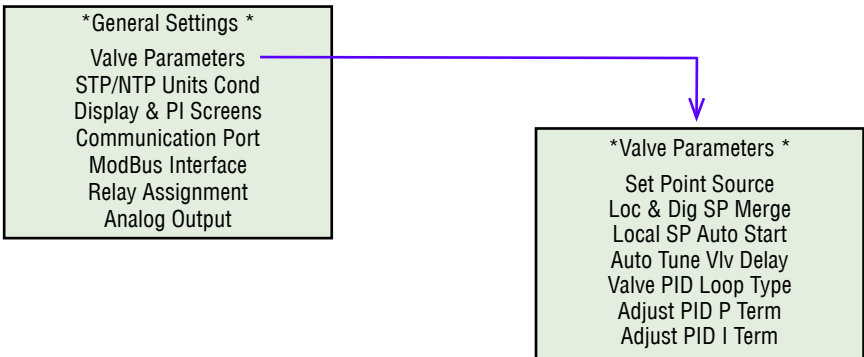

Figure 15: General Settings and Valve Parameters Menu Selections

Select “**Valve Parameters**” menu item and press **ENT**. A subsequent screen (Figure 15) will appear and the “**Valve Parameters**” menu items will be listed. Select “**Set Point Source**” menu item and press **ENT**. A subsequent screen (see Figure 16) will appear and the “**Set Point Source**” menu items will be listed. Select desired **Set Point Source** and press **ENT**.

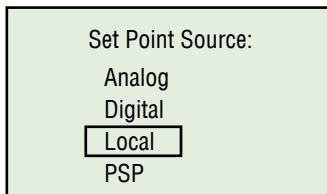
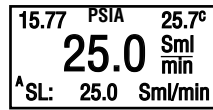
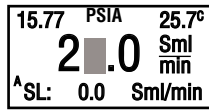
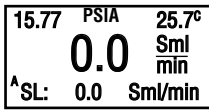

Figure 16: Set Point Source Menu Selections



NOTE: On power up, the last used **Set Point Source** settings will be retrieved from the instrument’s non-volatile memory and set as active.

To change “**Local**” **Set Point** value from main PI screen press Joystick **ENT**. The current set point value with rectangular flashing cursor will appear instead big digit flow reading (see Figure 17).



**Figure 17: Changing Local Set Point value**

Move the joystick **UP** or **DN** to increase or decrease digit value between 0-9 and decimal point. Move the joystick **RIGHT** or **LEFT** to move the cursor to another digit position. When the desired **Set Point** value is entered, use joystick equivalent of an **ENT** button to accept (to be saved in the EEPROM) the new value. Once saved, the new **Set Point** value will appear on the bottom of the screen and big digit flow reading will be restored.



**NOTE:** In order for controller to execute requested set point, the **Valve Mode** must be set to **Auto**.



**CAUTION:** Do not allow set points more than zero when controller's Valve Mode set to "Auto" and has zero differential pressure or does not have enough differential pressure to execute the requested flow. With these conditions the controller's PID loop will apply maximum power to the valve in order to reach the requested flow rate and valve may reach very high temperature!

DPC controller Valve Mode can be set in the one of the 3 following modes: **Closed**, **Auto**, **Opened**. The normal operating mode is "**Auto**". While controller's Valve Mode set in "**Auto**" it executes the set point according to the selected set point source. If controller's valve mode set to "**Close**" the valve will be closed regardless of the value of the set point. If controller's valve mode set to "**Open**" the valve will quickly switch to fully open (maximum control current) and user can expect huge uncontrolled flow (based on the differential pressure across the valve) through the instrument regardless the value of the set point. **This mode can make valve very hot and must be limited to no longer than 15 minutes.**

To change the Valve Mode from main PI screen move the joystick **RIGHT**. The PI screen will be replaced with subsequent screen (see **Figure 18**) and the "**Valve Operating Mode**" menu items will be listed. Move the joystick **UP** or **DN** to highlight required mode and press joystick **ENT** to accept (activate).

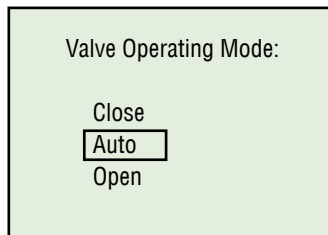

**Figure 18: Valve Mode Menu Selections**



**CAUTION:** Before selecting valve “Open” mode check Instrument Inlet Pressure! Make sure the differential pressure transient during valve opening will not exceed sensor maximum differential pressure. Improper usage may lead to damage of the instrument pressure sensors! Do not activate valve “Open” mode if instrument has more than 10 PSIG applied to the inlet and instrument output is connecting to the atmosphere!



**NOTE:** The Valve Mode menu selection only available from main PI screens 1 to 4 (see figure 10)

The “**Local & Digital Set Point Merge**” parameter if enabled allow change set point value via digital interface even the **Set Point Source** is assigned to “**Local Interface**”. The “**Local Set Point Auto Start**” parameter if enabled will automatically set valve mode in “**Auto**” after power is applied and start last saved **Local Set Point** execution (if **Set Point Source** parameter is set to “**Local**”). Consult factory for more information.

#### 6.4.4 Controller PID Parameters

**PID** Parameters determine the performance of proportional valve control algorithm. **P** refers to the **Proportional** term of the **PID** loop, **I** refers to the **Integral** term of the **PID** loop and **D** refers to the **Differential** term of the **PID** loop. These values impact control speed, valve stability, overshoot, undershoot and oscillation. DPC instruments shipped from the factory with a generic **PID** values designed to handle most applications. If your application required different settings (there are issues with valve stability, oscillation or speed), adjustment of these parameters may resolve the problem.



**CAUTION:** DPC instrument Valve PID parameters were adjusted on the factory according to your order and they allow to handle most applications. Do not change PID parameters unless instructed by factory technical support representative! It is recommended to contact factory technical support if DPC instrument exhibit any problem with stability, response time or different PID parameters are required for your application.

DPC instruments support 3 different implementations of the **PID** control loop algorithm: **PD**, **PID** and **PIDD**.

The **PD** algorithm is the default algorithm used on most DPC controllers and usually works fine for most generic applications with wide range of the differential pressure across the valve. With this algorithm the **Integral** term is disabled (not used).



**NOTE:** If **PID** loop type is changed, the **PID** parameters may need to be adjusted to work properly with different **PID** loop type.

The **PID** Loop Type can be selected from “**Valve PID Loop Type**” menu selection in the “**Valve Parameters**” menu.

The “**Start PID Auto Tune**” menu selection provides way to automatically find best **PID** terms values for most stable valve response but not necessary quickest. It may be used as starting point when new valve is installed and later “manual turning” can be used for fine turning and response time adjustment. Before starting “**PID Auto Tune**” procedure user should apply desired inlet pressure to the inlet of the DPC instrument and enter desired target “**Set Point**” value in %FS units. For most applications recommended set point values are between 50.0 and 90.0 %FS.

The “**Auto Tune Vlv Delay**” parameter only applicable for “**Auto Tune**” method and defines time interval in hundreds of ms between start of the set point command and start of the stability evaluation algorithm. The same time interval is used as delay for the next iteration of the Auto Turning process. For slower instruments (low flow rates instruments < 50 sml/min full scale) it is recommended use longer delay (500 to 2000 ms).

The “**AT Oscillations Criteria**” parameter also only applicable for “**Auto Tune**” method and defines peak to peak amplitude (difference between minimum and maximum flow reading) of the flow expressed in the % full scale, which will be considered as oscillations (valve unstable operation) . For most applications recommended value 2.0% FS is a good starting point.

Depending on the valve adjustment and application parameters “**Auto Tune**” process can take from 0.5 to 3 minutes to complete. During the “**Auto Tune**” process the software will display the current (used for particular flow transient iteration) **PID** settings and status of the process. When completed the software will prompt with success or failure message. If “**Auto Tune**” process successfully completed the new **PID** parameters will be automatically saved in the instrument’s non-volatile memory.

The “**Restore Valve PID**” menu selection can be used to restore factory original **PID** parameters settings.

To improve controller speed or adjust instrument response for custom application, the manual **PID** turning is more suitable. Manual turning involves finding individual **PID** terms which reflects the quickest response with minimum oscillations. It is recommended to perform “**Manual Turning**” with simultaneous monitoring of the instrument analog output signal (0-5 or 0-10 Vdc) on the Digital Oscilloscope. Doing so will allow to perform fine turning when quick response times (100 - 200 ms) are required.

It is recommended use supplied by AALBORG free “**DPCM Communication Utility**” software to perform **PID** manual turning. The software “**Tools/Valve PID Turning**” menu selection provides convenient interface to control instrument set point and manually adjust individual **PID** terms values according to instrument response. In some cases the fine **PID** loop turning can be complicated. If you need assistance contact AALBORG for technical support.

#### **6.4.5 Submenu “Device Information”**

This submenu contains information about the device’s main configuration parameters. These items are informational only, not password-protected, and cannot be changed (read only).

### 6.4.6 Submenu “Units of Measure”

Use the “Units of Measure” Menu to navigate to Measuring Units settings for Mass Flow, Volumetric Flow, Pressure, and Temperature readings. This option allows configuration of the flow controller with the desired units of measurement. These are global settings and determine what appears on all Process Information screens and in all data log records. Units should be selected to meet your particular metering needs. A total of 44 different massbased engineering units (Standard, Normal and True Mass) are supported (see Table VI). A total of 15 different volumetric flow rate units are supported (see Table VII).

Supported Pressure units of measure are listed in Table VIII, and Supported Temperature units of measure are listed in Table IX.

<b>TABLE VI: LIST OF SUPPORTED MASS FLOW UNITS OF MEASURE</b>			
<b>Number</b>	<b>Mass Flow Rate Units</b>	<b>Totalizer Volume Units</b>	<b>Description</b>
<b>STANDARD</b>			
1	%FS	%s	Percent of Full Scale
2	SuL/min	SuL	Microliters per minute
3	SmL/sec	SmL	Milliliter per second
4	SmL/min	SmL	Milliliters per minute
5	SmL/hr	SmL	Milliliter per hour
6	SL/sec	SL	Liter per second
7	SL/min	SL	Liter per minute
8	SL/hr	SL	Liter per hour
9	SL/day	SL	Liter per day
10	Sm3/min	Sm3	Cubic meter per minute
11	Sm3/hr	Sm3	Cubic meter per hour
12	Sm3/day	Sm3	Cubic meter per day
13	Sf3/sec	Sf3	Cubic feet per second
14	Sf3/min	Sf3	Cubic feet per minute
15	Sf3/hr	Sf3	Cubic feet per hour
16	Sf3/day	Sf3	Cubic feet per day
<b>TRUE MASS</b>			
17	gr/sec	gr	Grams per second
18	gr/min	gr	Grams per minute
19	gr/hr	gr	Grams per hour
20	gr/day	gr	Grams per day
21	kg/min	kg	Kilograms per minute
22	kg/hr	kg	Kilograms per hour
23	kg/day	kg	Kilograms per day



**TABLE VI (CONTINUED): LIST OF SUPPORTED MASS FLOW UNITS OF MEASURE**

<b>Number</b>	<b>Mass Flow Rate Units</b>	<b>Totalizer Volume Units</b>	<b>Description</b>
<b>TRUE MASS</b>			
24	lb/min	lb	Pounds per minute
25	lb/hr	lb	Pounds per hour
26	lb/day	lb	Pounds per day
27	oz/sec	oz	Ounce per second
28	oz/min	oz	Ounce per minute
<b>NORMAL</b>			
29	NuL/min	NuL	Microliters per minute
30	NmL/sec	NmL	Milliliter per second
31	NmL/min	NmL	Milliliters per minute
32	NmL/hr	NmL	Milliliter per hour
33	NL/sec	NL	Liter per second
34	NL/min	NL	Liter per minute
35	NL/hr	NL	Liter per hour
36	NL/day	NL	Liter per day
37	Nm3/min	Nm3	Cubic meter per minute
38	Nm3/hr	Nm3	Cubic meter per hour
39	Nm3/day	Nm3	Cubic meter per day
40	Nf3/sec	Nf3	Cubic feet per second
41	Nf3/min	Nf3	Cubic feet per minute
42	Nf3/hr	Nf3	Cubic feet per hour
43	Nf3/day	Nf3	Cubic feet per day
<b>USER DEFINED</b>			
44	USER	U	User Defined

**TABLE VII: LIST OF SUPPORTED VOLUMETRIC FLOW UNITS OF MEASURE**

Number	Flow Rate Units	Totalizer Volume Units	Description
1	%FS	%s	Percent of Full Scale
2	uL/min	uL	Microliters per minute
3	mL/sec	mL	Milliliter per second
4	mL/min	mL	Milliliters per minute
5	mL/hr	mL	Milliliter per hour
6	L/sec	L	Liter per second
7	L/min	L	Liter per minute
8	L/hr	L	Liter per hour
9	L/day	L	Liter per day
10	m3/min	m3	Cubic meter per minute
11	m3/hr	m3	Cubic meter per hour
12	m3/day	m3	Cubic meter per day
13	f3/sec	f3	Cubic feet per second
14	f3/min	f3	Cubic feet per minute
15	f3/hr	f3	Cubic feet per hour
16	f3/day	f3	Cubic feet per day

**TABLE VIII: LIST OF SUPPORTED ABSOLUTE PRESSURE UNITS OF MEASURE**

Number	Pressure Units Name	Short Name	Description
1	PSIA	psiA	Pound per square inch
2	barA	barA	bar
3	mbarA	mbar	Millibar
4	hPaA	hPaA	Hecto Pascal
5	kPaA	kPaA	Kilo Pascal
6	MPaA	MPaA	Mega Pascal
7	atm	atm	Atmosphere
8	g/cm2A	gcm2	Gram-force per square centimeter
9	kg/cmA	kgc2	Kilogram-force per square centimeter
10	inHgA	inHg	Inch of mercury [0°C]
11	mmHgA	mmHg	Millimeter of mercury [0°C]
12	cmH2OA	cmH2	Centimeter of water [4°C]
13	inH2OA	inH2	Inch of water [4°C]
14	TorrA	torr	Torr
15	%FS	%FS	Percent of Full Scale

TABLE IX: LIST OF SUPPORTED TEMPERATURE UNITS OF MEASURE		
Number	Temperature Units Label	Description
1	°F	degree Fahrenheit
2	°C	degree Celsius
3	K	Kelvin
4	°R	degree Rankine



NOTE: Program the Measuring Units first because subsequent menus may be based on the units selected. Once Flow Unit of Measure is changed, the Totalizer's Unit of Measure will be automatically updated.

### 6.4.7 “Submenu User-Defined Units”

In addition to conventional flow units, user-defined flow engineering units may be selected. Use the “**Engineering Units and K-Factor**” menu to navigate to the “**User-Defined Units**” menu option. This option enables user defined configuration of any engineering unit required for process measurement.

The following three parameters are available for this function:

- UD Unit volume K-Factor (defined in Liters)
- UD Unit time base (defined in Seconds)
- UD Unit use density (units with or without density support)

Before using the User-Defined Unit, be sure the proper conversion factor of the new unit, with respect to one liter, is set. The default entry is 1.00 Liter. Also, proper time-based values for User-Defined Units must be set.

**Figure 19** explains by diagram the various upper level display menus.

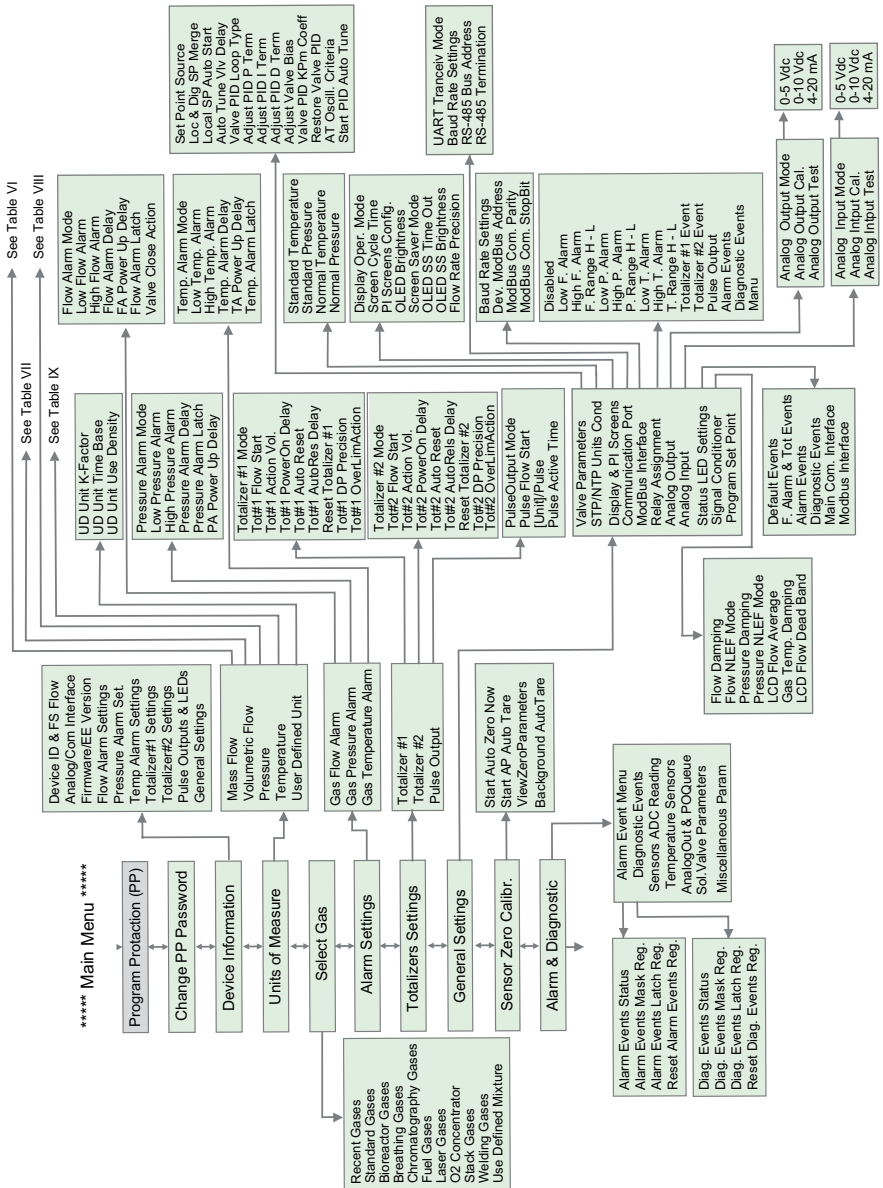
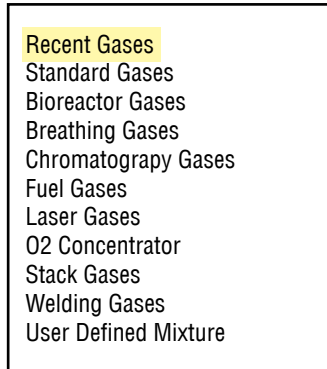

Figure 19: DPC Upper Levels Menu Structure

### 6.4.8 Submenu "Select Gas"

The currently active gas can be selected by the user via OLED/joystick or digital communication interface. The gas data are allocated in different gas groups (see **Figure 20** below). The "**Recent Gases**" group keeps up to 16 recently selected gases. The detailed list of the gases for each group is provided in **Tables X** through **XVIII**, beginning on the following page.

For example, to select Nitrogen, the user should navigate to "**Select Gas**"→"**Standard Gases**", then highlight "**Nitrogen**" and press the joystick equivalent of an **Ent** button.



**Figure 20:** Selecting Gas Group

**TABLE X: Standard Pure Non-Corrosive Gases**  
**All Data for Standard Conditions (70 °F and 14.696 PSIA)**

<b>Gas Number</b>	<b>Short Name</b>	<b>Long Name</b>	<b>Absolute Viscosity (μPa-s)</b>	<b>Density g/l</b>	<b>Compressibility</b>
0	Air	Air	18.259686	1.2000185	0.99963453
1	Ar	Argon	22.377244	1.6555318	0.99932392
2	CO2	Carbon Dioxide	14.743078	1.8322844	0.99473012
3	N2	Nitrogen	17.624584	1.1604245	0.99976728
4	O2	Oxygen	20.3345	1.3261455	0.99930979
5	He	Helium	19.668342	0.16568373	1.0004913
6	CO	Carbon Monoxide	17.475804	1.1604842	0.99959984
7	C2H4	Ethylene	10.187017	1.168818	0.99401503
8	C2H6	Ethane	9.2398038	1.255226	0.99208387
9	n-C4H10	n-Butane	7.3072193	2.4852646	0.96854578
10	i-C4H10	i-Butane	7.4018705	2.4755419	0.97234976
11	C3H8	Propane	8.0415054	1.857567	0.98310908
12	D2	Deuterium	12.473107	0.16672796	1.0005847
13	H2	Hydrogen	8.8198202	0.083436355	1.0005991
14	N2O	Nitrous Oxide	14.654788	1.8332083	0.99430109
15	CH4	Methane	10.949931	0.66562262	0.99816159
16	Ne	Neon	30.847242	0.83530908	1.0004838
17	Kr	Krypton	24.839148	3.4779701	0.9978346
18	SF6	Sulfur Hexafluoride	15.042726	6.121213	0.98816832
19	Xe	Xenon	22.710043	5.4674713	0.99450233
20	C2H2	Acetylene	10.334757	3.4606011	0.99244221
21	C25	25% CO2 / 75% Ar	20.455223	1.6988495	0.99859725
22	C10	10% CO2 / 90% Ar	21.609367	1.672811	0.99905731
23	C8	8% CO2 / 92% Ar	21.762981	1.6693503	0.9991131
24	C2	2% CO2 / 98% Ar	22.223694	1.6589828	0.99927304
25	C75	75% CO2 / 25% Ar	16.611552	1.7870162	0.99639528
26	He75	75% He / 25% Ar	23.052769	0.53762966	1.0005554
27	He25	25% He / 75% Ar	23.043143	1.2822075	1.0000347
28	A1025	90% He / 7.5% Ar / 2.5% CO2	21.314678	0.31866435	1.0005383
29	Star29	Stargon CS 90% Ar/8%CO2/2%O2	21.730903	1.6627585	0.99911456
30	P5	95% Ar / 5% CH4	22.146573	1.6060633	0.99928305

**TABLE XI: Bioreactor Gases**  
**All Data for Standard Conditions (70 °F and 14.696 PSIA)**

<b>Gas Number</b>	<b>Short Name</b>	<b>Long Name</b>	<b>Absolute Viscosity (μPa-s)</b>	<b>Density g/l</b>	<b>Compressibility</b>
36	Bio-5M	5%CH <sub>4</sub> / 95%CO <sub>2</sub>	14.653659	1.7701352	0.99498978
37	Bio-10M	10%CH <sub>4</sub> / 90%CO <sub>2</sub>	14.559299	1.7147013	0.99523243
38	Bio-15M	15%CH <sub>4</sub> / 85%CO <sub>2</sub>	14.459421	1.6564349	0.99544756
39	Bio-20M	20%CH <sub>4</sub> / 80%CO <sub>2</sub>	14.353426	1.5978991	0.99567147
40	Bio-25M	25%CH <sub>4</sub> / 75%CO <sub>2</sub>	14.24079	1.5394019	0.99588751
41	Bio-30M	30%CH <sub>4</sub> / 70%CO <sub>2</sub>	14.120874	1.4809418	0.9960956
42	Bio-35M	35%CH <sub>4</sub> / 65%CO <sub>2</sub>	13.992953	1.4225176	0.99629569
43	Bio-40M	40%CH <sub>4</sub> / 60%CO <sub>2</sub>	13.856199	1.3641278	0.99648773
44	Bio-45M	45%CH <sub>4</sub> / 55%CO <sub>2</sub>	13.709659	1.3057712	0.99667173
45	Bio-50M	50%CH <sub>4</sub> / 50%CO <sub>2</sub>	13.55223	1.2474461	0.99684765
46	Bio-55M	55%CH <sub>4</sub> / 45%CO <sub>2</sub>	13.382616	1.1891512	0.99701551
47	Bio-60M	60%CH <sub>4</sub> / 40%CO <sub>2</sub>	13.1993	1.1308852	0.99717531
48	Bio-65M	65%CH <sub>4</sub> / 35%CO <sub>2</sub>	13.000513	1.0726464	0.99732702
49	Bio-70M	70%CH <sub>4</sub> / 30%CO <sub>2</sub>	12.784241	1.0144337	0.99747066
50	Bio-75M	75%CH <sub>4</sub> / 25%CO <sub>2</sub>	12.548154	0.95624539	0.9976062
51	Bio-80M	80%CH <sub>4</sub> / 20%CO <sub>2</sub>	12.289467	0.89808023	0.99773363
52	Bio-85M	85%CH <sub>4</sub> / 15%CO <sub>2</sub>	12.004793	0.83993679	0.99785292
53	Bio-90M	90%CH <sub>4</sub> / 10%CO <sub>2</sub>	11.690063	0.78181364	0.99796403
54	Bio-95M	95%CH <sub>4</sub> / 5%CO <sub>2</sub>	11.340435	0.72370939	0.99806694

**TABLE XII: Breathing Gases**  
**All Data for Standard Conditions (70 °F and 14.696 PSIA)**

<b>Gas Number</b>	<b>Short Name</b>	<b>Long Name</b>	<b>Absolute Viscosity (μPa-s)</b>	<b>Density g/l</b>	<b>Compressibility</b>
56	EAN-32	32%O2 / 68%N2	18.553594	1.2134468	0.99961365
57	EAN-36	36%O2 / 64%N2	18.665372	1.2200749	0.99959516
58	EAN-40	40%O2 / 60%N2	18.77622	1.2267031	0.9995768
59	HeOx-20	20%O2 / 80%He	21.160783	0.39742666	1.000575
60	HeOx-21	21%O2 / 79%He	21.164401	0.40901481	1.0005744
61	HeOx-30	30%O2 / 70%He	21.120337	0.51331687	1.0005531
62	HeOx-40	40%O2 / 60%He	20.99441	0.62923199	1.0005002
63	HeOx-50	50%O2 / 50%He	20.851246	0.7451824	1.0004169
64	HeOx-60	60%O2 / 40%He	20.714981	0.86118182	1.0002995
65	HeOx-80	80%O2 / 20%He	20.499515	1.0934087	0.99993193
66	HeOx-99	99%O2 / 1%He	20.338992	1.3144914	0.99934879
67	EA-40	Enri Air-40%O2	19.15564	1.2505528	0.99951725
68	EA-60	Enri Air-60%O2	19.56039	1.2757473	0.9994476
69	EA-80	Enri Air-80%O2	19.953017	1.3009447	0.99937862
70	Metabol	Metabolic Exhalant (16%O2 / 78.04%N2 / 5%CO2 / 0.96%Ar)	18.04915	1.2250145	0.99952679

**TABLE XIII: Chromatography Gases**  
**All Data for Standard Conditions (70 °F and 14.696 PSIA)**

<b>Gas Number</b>	<b>Short Name</b>	<b>Long Name</b>	<b>Absolute Viscosity (μPa-s)</b>	<b>Density g/l</b>	<b>Compressibility</b>
71	P-5	5%CH4 / 95%Ar	22.146573	1.6060633	0.99928305
72	P-10	10%CH4 / 90%Ar	21.899835	1.5565932	0.99924058



**TABLE XIV: Fuel Gases**  
**All Data for Standard Conditions (70 °F and 14.696 PSIA)**

<b>Gas Number</b>	<b>Short Name</b>	<b>Long Name</b>	<b>Absolute Viscosity (μPa-s)</b>	<b>Density g/l</b>	<b>Compressibility</b>
74	SynG-1	40%H2 / 29%CO / 20%CO2 / 11%CH4	15.253299	0.80779626	0.99952272
75	SynG-2	64%H2 / 28%CO / 1%CO2 / 7%CH4	14.781416	0.44282577	1.0003283
76	SynG-3	70%H2 / 4%CO / 25%CO2 / 1%CH4	14.725047	0.5672004	0.99990018
77	SynG-4	83%H2 / 14%CO / 3%CH4	13.737274	0.25149803	1.0005186
78	NatG-1	93%CH4 / 3%C2H6 / 1%C3H8 / 2%N2 / 1%CO2	11.020257	0.71638178	0.9979886
79	NatG-2	95%CH4 / 3%C2H6 / 1%N2 / 1%CO2	11.006305	0.69973554	0.99804196
80	NatG-3	95.2CH4 / 2.5%C2H6 / 0.2%C3H8 / 0.1%n-C4H10 / 1.3%N2 / 0.7%CO2	10.99793	0.69890329	0.99804914
81	Coal Gas	50%H2 / 35%CH4 / 10%CO / 5%C2H4	12.23411	0.47642496	0.9988977
82	Endo	75%H2 / 25%N2	13.712892	0.35247105	1.0005199
83	HHO	66.67%H2 / 33.33%O2	16.838285	0.49714469	1.0004234
84	HD-5	LPG 96.2%C3H8 / 1.5%C2H6 / 0.4%C3H6 / 1.9%n-C4H10	8.0566953	1.8596915	0.98305588
85	HD-10	LPG 85%C3H8 / 10%C3H6 / 5%n-C4H10	8.060707	1.8793052	0.98275016

**TABLE XV: Laser Gases**  
**All Data for Standard Conditions (70 °F and 14.696 PSIA)**

Gas Number	Short Name	Long Name	Absolute Viscosity (μPa-s)	Density g/l	Compressibility
89	LG-4.5	4.5%CO2 / 13.5%N2 / 82%He	19.875867	0.37436617	1.0005373
90	LG-6	6%CO2 / 14%N2 / 80%He	19.810188	0.4041824	1.0005193
91	LG-7	7%CO2 / 14%N2 / 79%He	19.76977	0.42074815	1.0005058
92	LG-9	9%CO2 / 15%N2 / 76%He	19.644085	0.46382218	1.0004745
93	HeNe-9	9%Ne / 91%He	22.266969	0.22372402	1.0004795
94	LG-9.4	9.4%CO2 / 19.25%N2 / 71.35%He	19.488366	0.51269615	1.0004588

**TABLE XVI: O<sub>2</sub> Concentrator Gases**  
**All Data for Standard Conditions (70 °F and 14.696 PSIA)**

Gas Number	Short Name	Long Name	Absolute Viscosity (μPa-s)	Density g/l	Compressibility
99	OCG-89	89%O <sub>2</sub> / 7%N <sub>2</sub> / 4%Ar	20.276364	1.3277141	0.99934333
100	OCG-93	93%O <sub>2</sub> / 3%N <sub>2</sub> / 4%Ar	20.373369	1.334345	0.99932581
101	OCG-95	95%O <sub>2</sub> / 1%N <sub>2</sub> / 4%Ar	20.421571	1.3376605	0.99931705

**TABLE XVII: Stack Gases**  
**All Data for Standard Conditions (70 °F and 14.696 PSIA)**

Gas Number	Short Name	Long Name	Absolute Viscosity (μPa-s)	Density g/l	Compressibility
104	FG-1	2.5%O <sub>2</sub> / 10.8%CO <sub>2</sub> / 85%N <sub>2</sub> / 1%Ar	17.553974	1.2415291	0.99938947
105	FG-2	2.9%O <sub>2</sub> / 14%CO <sub>2</sub> / 82.1%N <sub>2</sub> / 1%Ar	17.489167	1.2635492	0.99927301
106	FG-3	3.7%O <sub>2</sub> / 15%CO <sub>2</sub> / 80.3%N <sub>2</sub> / 1%Ar	17.484521	1.2715509	0.99923323
107	FG-4	7%O <sub>2</sub> / 12%CO <sub>2</sub> / 80%N <sub>2</sub> / 1%Ar	17.642257	1.2569936	0.99932823
108	FG-5	10%O <sub>2</sub> / 9.5%CO <sub>2</sub> / 79.5%N <sub>2</sub> / 1%Ar	17.781725	1.2452832	0.99940281
109	FG-6	13%O <sub>2</sub> / 7%CO <sub>2</sub> / 79%N <sub>2</sub> / 1%Ar	17.922258	1.2335784	0.99947428

**TABLE XVIII: Welding Gases**  
**All Data for Standard Conditions (70 °F and 14.696 PSIA)**

<b>Gas Number</b>	<b>Short Name</b>	<b>Long Name</b>	<b>Absolute Viscosity (μPa-s)</b>	<b>Density g/l</b>	<b>Compressibility</b>
114	C-2	2%CO2 / 98%Ar	22.223694	1.6589828	0.99927304
115	C-8	8%CO2 / 92%Ar	21.762981	1.6693503	0.9991131
116	C-10	10%CO2 / 90%Ar	21.609367	1.672811	0.99905731
117	C-15	15%CO2 / 85%Ar	21.225138	1.6814739	0.99891226
118	C-20	20%CO2 / 80%Ar	20.840474	1.6901531	0.99875902
119	C-25	25%CO2 / 75%Ar	20.455223	1.6988495	0.99859725
120	C-50	50%CO2 / 50%Ar	18.525065	1.7426245	0.99764493
121	C-75	75%CO2 / 25%Ar	16.611552	1.7870162	0.99639528
122	He-25	25%He / 75%Ar	23.043143	1.2822075	1.0000347
123	He-50	50%He / 50%Ar	23.466653	0.90972133	1.0004058
124	He-75	75%He / 25%Ar	23.052769	0.53762966	1.0005554
125	He-90	90%He / 10%Ar	21.816616	0.31445794	1.0005487
126	A1025	90%He / 7.5%Ar / 2.5%CO2	21.314678	0.31866435	1.0005383
127	Star29	Stargon CS 90%Ar / 8%CO2 / 2%O2	21.730903	1.6627585	0.99911456

#### **6.4.9 Submenu “User-Defined Mixture”**

Submenu “**User-Defined Mixture**” allows the user to create and save up to 20 custom gas mixtures. Each gas mixture may have from 2 to 5 gases from those listed in **Tables X** through **XVIII**.



**Figure 21:** Add Mixture Menu Selection

By default, the instrument has no preset mixtures in the memory, and there is room for 20 user-defined mixtures (see **Figure 21**). Press the joystick equivalent of an **Ent** button to assign a name to the new gas mixture (see **Figure 22**). The flashing cursor with letter “A” will appear. Move the joystick **UP** and **DN** to change letters and numbers. Once the desired letter (or number) is set, use the joystick **RIGHT** command to move the cursor to the next position. Use **LEFT** to toggle the letter case. Press the joystick equivalent of **Ent** to save the gas mixture name.

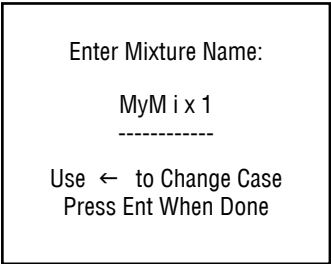

**Figure 22:** Assigning a Name to the Mixture

Once the gas mixture name is saved, the screen shown in **Figure 23** will appear. To select the gas component for G1, press the joystick equivalent of an **Ent** button. As shown in **Figure 24**, a screen with a list of gases will appear.

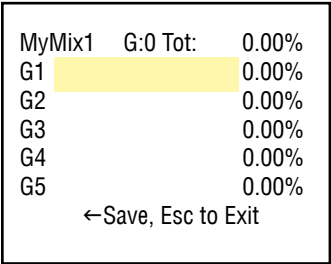

**Figure 23:** Add Gas Component and Ratio



**NOTE:** Use the joystick **Up** and **Down** to select another component, and **Right** and **Left** to switch between Gas Name and Ratio entry.

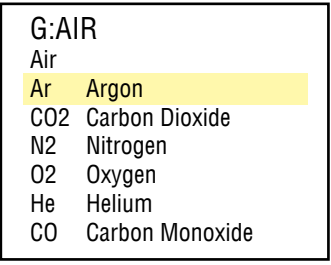

**Figure 24:** Selecting Gas Component



NOTE: Use the joystick **Up** and **Down** to highlight the required gas. Press the joystick equivalent of **Enter** to select a gas.

MyMix1	G:0	Tot: 0.00%
G1	Ar	0.00%
G2		0.00%
G3		0.00%
G4		0.00%
G5		0.00%
←Save, Esc to Exit		

**Figure 25:** G1 Component with Selected Gas

Once the gas is selected for component G1, the screen shown in **Figure 25** will appear. To select the ratio for component G1, press **Right**. The screen shown in the top of **Figure 26** will appear. To start entering a ratio value in %, press the joystick equivalent of **Enter**. The G1 component will appear at the bottom of the screen, with a flashing cursor. The user can now enter the desired ratio value for this gas, as shown second screen in **Figure 26**:

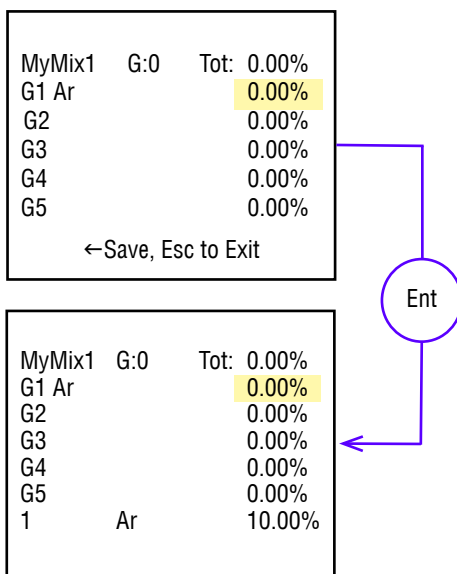

**Figure 26:** G1 Component with Highlighted Ratio Value



NOTE: Use the joystick **Up** and **Down** to change numerical value, and **Left** and **Right** to change cursor position. Once the required ratio value is entered, press the joystick equivalent of **Enter** to accept it.

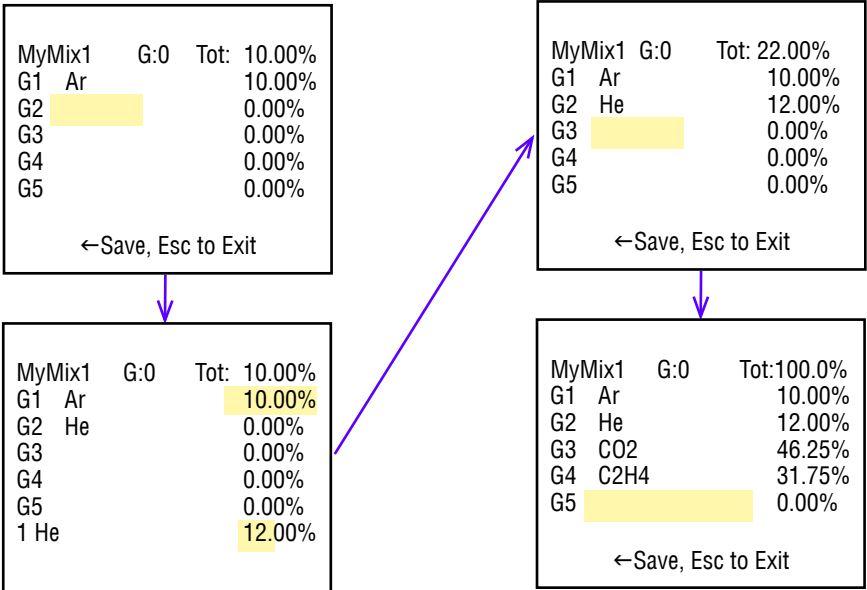

**Figure 27:** Mixture with 4 Components Ready to be Saved

Continue adding up to 5 gases, as required for your application. See **Figure 27** for an example of a mixture of 4 components ready to be saved. The total mixture must be 100% to be accepted. An error message will appear if the user tries to save a mixture that does not total 100%. When it is ready, press **Left** to save the mixture. The instrument will prompt with a confirmation message (see **Figure 28**):

```

*****
NEW MIXTURE
HAS BEEN SAVED
*****
Press any key...

```

**Figure 28:** Mixture Saved Confirmation Message

As directed in the above screen, press any button on the joystick to move to the next screen. Now that the mixture has been saved, it will appear in the “**User-Defined Mixture**” menu selection (see **Figure 29**):



**Figure 29: “User-Defined Mixture” Menu Selection with new MyMix1 Mixture**

Any saved mixture can be edited by the user. In order to edit a saved mixture, highlight it using **Up** or **Down** and then pressing **Left**. The confirmation message shown in **Figure 30** will appear. Select “**YES**” then press the joystick equivalent of **Enter**.

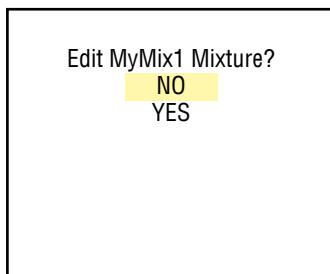

**Figure 30: "Edit Mixture" Menu Selection**

In the edit mixture mode, the user can change the mixture name, any gas component gas name, and any ratio value.

#### **6.4.10 Submenu “Gas Flow Alarm”**

The DPC provides the user with a flexible Alarm warning system that monitors the Fluid Flow for all conditions that fall outside configurable limits, as well as visual feedback for the user via the OLED, status LED or an SSR output. The Flow Alarm has several attributes which may be configured by the user via OLED/joystick interface or digital communication interface. These attributes control the conditions that cause the Alarm to occur and specify actions to be taken when the flow rate is outside the specified conditions.

Flow Alarm conditions become true when the absolute value of the difference between current flow reading and set point value is equal or higher than corresponding value of High or Low Flow Alarm levels. Alarm action can be assigned with a preset Delay interval of 0 to 3600 seconds before activating the SSR output. In most applications, the user will want to have a brief delay (2-10 seconds) to qualify that the flow rate is really settled at a chosen level and has not spiked because of some interference. The Latch Mode control feature allows SSR output to be latched on or to follow the corresponding Alarm status.

The following settings are available for the Flow Alarm (see **Figure 19**):

**a) Flow Alarm Mode (Tabular entry)**

This function determines whether the Flow Alarm is Enabled or Disabled, the only two selections available. The default entry is Disabled. Alarm Mode selections can be set with the joystick **UP** and **DN** buttons, and are accepted by pressing the joystick equivalent of the **ENT** button.

**b) Low Flow Alarm (Numerical entry)**

The limit of the required Low Flow Alarm value can be entered in increments of 0.1%, from 0 to 110.0% FS (Full Scale).

If a Low Alarm occurs, and SSR output is assigned to the Low Flow Alarm Event (see Section 6.4.15.6), the SSR output will be activated when the absolute value of the difference between flow rate and set point value equal or more than the Low Flow Alarm value and flow rate is lower than set point value.

The Low Flow Alarm condition is also indicated on the corresponding Process Information screen by alternating every second between units of measure and the alert “Lo!” (meaning low flow).



**NOTE:** Use Low Flow Alarm to monitor conditions when actual flow rate falling below the set point value.

**c) High Flow Alarm (Numerical entry)**

The limit of the required High Flow Alarm value can be entered in increments of 0.1%, from 0 to 110% FS (Full Scale). If a High Alarm occurs, and the SSR output is assigned to the High Flow Alarm Event (see Section 6.4.15.6), the SSR output will be activated when the absolute value of the difference between flow rate and set point value equal or more than the High Flow Alarm value and flow rate is higher than set point value.

The High Flow Alarm condition is also indicated on the corresponding Process Information screen by alternating every second between units of measure and the alert “Hi!” (meaning High flow).



**NOTE:** Use High Flow Alarm to monitor conditions when actual flow rate rising above the set point value.

**d) Flow Alarm Action Delay (Numerical entry)**

The Flow Alarm Action Delay is a time period in seconds that the Flow Rate value may remain above the High limit or below the Low limit before an Alarm condition is activated. Valid settings are in the range of 0 to 3600 seconds. The default value is 0: no delay.



#### **e) Flow Alarm Power On Delay (Numerical entry)**

Sometimes it is convenient to enable the Flow Alarm only after a specified power-up delay interval. The “**Flow Alarm Power On Delay**” option allows the user to set a specified time interval which must elapse from the moment of the device power-up event before the Flow Alarm function will be activated. Valid settings are in the range of 0 to 3600 seconds. The default value is 0: no delay.

#### **f) Flow Alarm Action Latch (Tabular entry)**

The Flow Alarm Action Latch settings control the Latch features. If SSR output is assigned to the Flow Alarm event, in some cases the Flow Alarm Latch feature may be desirable. The following settings are available: Enabled or Disabled. By default, the Flow Alarm is nonlatching, which means that the Alarm action is indicated only while the monitored Flow Rate value exceeds the specified conditions that have been set.

#### **g) Valve Close Action (Tabular entry)**

In some applications it may be required to stop gas flow if actual flow is outside of the target range. In this case “**Valve Close Action**” can be used. This menu selection has 3 available options: **Disabled**, **High Alarm**, and **Low Alarm**. When assigned to **High** or **Low Alarm** and corresponding Alarm conditions activated the instrument control valve will be de-energized (Closed).

### **6.4.11 Submenu “Gas Pressure Alarm”**

The DPC provides the user with a flexible Alarm system that monitors the Fluid Pressure for conditions that fall outside configurable limits and provides visual feedback for the user via the OLED, status LED or an SSR output. The Pressure Alarm has several attributes which may be configured by the user via the OLED/joystick interface or digital communication interface. These attributes control the conditions that cause the Alarm to occur and specify actions to be taken when the pressure reading is outside the specified conditions.

Pressure Alarm conditions become true when the current pressure reading is equal to, higher than or lower than the corresponding values of High and Low Pressure Alarm levels.

Alarm action can be assigned with a preset Delay Interval (0-3600 seconds) to activate the SSR output. The Latch Mode control feature allows SSR output to be latched on or follow the corresponding Alarm status.

The following settings are available for the Pressure Alarm (see **Figure 19**):

#### **a) Pressure Alarm Mode (Tabular entry)**

This function determines whether the Pressure Alarm is Enabled or Disabled, the two selections available. The default entry is Disabled. Alarm Mode selections can be set with the Joystick **UP** and **DN** buttons and are accepted by pressing the joystick equivalent of an **ENT** button.

### **b) Low Pressure Alarm (Numerical entry)**

The limit of required Low Pressure Alarm value can be entered in currently selected pressure units, in increments of 0.1% of the pressure full scale range from 0.0 to 99.9%.

If a Low Alarm occurs, and SSR output is assigned to the Low Pressure Alarm event (see Section 6.4.15.6) the SSR output will be activated when the pressure is less than the Low Pressure Alarm value.

The Low Pressure Alarm condition is also indicated on the corresponding Process Information Screen by alternating every second between units of measure and the alert "LOW!"



NOTE: The value of the Low Pressure Alarm must be less than the value of the High Pressure Alarm.

### **c) High Pressure Alarm (Numerical entry)**

The limit of required High Pressure Alarm value can be entered in currently selected pressure units, in increments of 0.1% of the pressure sensor full scale range from 0.1 to 100%.

If a High Alarm occurs, and SSR output is assigned to the High Pressure Alarm event (see Section 6.4.15.6), the SSR output will be activated when the pressure reading is more than the High Pressure Alarm value.

The High Pressure Alarm condition is also indicated on the corresponding Process Information Screen by alternating every second between units of measure and the alert "HIGH!"



NOTE: The value of the High Pressure Alarm must be greater than the value of the Low Pressure Alarm.

### **d) Pressure Alarm Action Delay (Numerical entry)**

The Pressure Alarm Action Delay is a time period in seconds that the Pressure Reading value may remain above the High limit or below the Low limit before an Alarm condition is activated. Valid settings are in the range of 0 to 3600 seconds. The default value is 0: no delay.

### **e) Pressure Alarm Power On Delay (Numerical Entry)**

Sometimes it is convenient to enable the Pressure Alarm only after a specified power-up delay interval. The "**Pressure Alarm Power On Delay**" option allows the user to set a specified time interval which must elapse from the moment of the device power-up event before the Pressure Alarm function will be activated. Valid settings are in the range of 0 to 3600 seconds. The default value is 0: no delay.

### **f) Pressure Alarm Action Latch (Tabular entry)**

The Pressure Alarm Action Latch settings control the Latch features. If SSR output is assigned to the Pressure Alarm event, in some cases the Pressure Alarm Latch feature may be desirable.

The following settings are available: Enabled or Disabled. By default, the Pressure Alarm is non-latching, which means that the Alarm action is indicated only while the monitored Pressure reading value exceeds the specified conditions that have been set.

## **6.4.12 Submenu "Gas Temperature Alarm"**

The DPC provides the user with a flexible Alarm system that monitors the Fluid Temperature for conditions that fall outside configurable limits and provides visual feedback for the user via the OLED, status LED or an SSR output. The Temperature Alarm has several attributes which may be configured by the user via the OLED/joystick interface or digital communication interface. These attributes control the conditions which cause the Alarm to occur and specify actions to be taken when the temperature reading rate is outside the specified conditions.

Temperature Alarm conditions become true when the current temperature reading is equal to, or higher or lower than, corresponding values of High and Low Temperature Alarm levels.

Alarm action can be assigned with preset Delay Interval (0-3600 seconds) to activate the SSR output. The Latch Mode control feature allows SSR output to be latched on or follow the corresponding Alarm status.

Following settings are available for Temperature Alarm (see **Figure 19**):

### **a) Temperature Alarm Mode (Tabular entry)**

This function determines whether the Temperature Alarm is Enabled or Disabled. Two selections are available: Enabled or Disabled. The default entry is Disabled. Alarm Mode selections can be set with the Joystick **UP** and **DN** buttons and are accepted by pressing the joystick equivalent of an **ENT** button.

### **b) Low Temperature Alarm (Numerical entry)**

The limit for the Low Temperature Alarm value can be entered in currently selected temperature units, in increments of 0.1 degree within the range of -20 °C to 69.9 °C.

If a Low Alarm occurs, and SSR output is assigned to the Low Temperature Alarm event (see Section 6.4.15.6), the SSR output will be activated when the temperature is lower than the preset Low Temperature Alarm value.

The Low Temperature Alarm condition is also indicated on the corresponding Process Information Screen by alternating every second between units of measure and the "L" alert, meaning Low.



NOTE: The value of the Low Temperature Alarm must be less than the value of the High Temperature Alarm.

### **c) High Temperature Alarm (Numerical entry)**

The limit of the required High Temperature Alarm value can be entered in currently selected units, in increments of 0.1 degree within the range of -19.9 °C to 70.0 °C. If a High Alarm occurs, and SSR output is assigned to the High Temperature Alarm event (see Section 6.4.15.6), the SSR output will be activated when the Temperature reading is greater than the High Temperature Alarm value.

The High Temperature Alarm condition is also indicated on the corresponding Process Information Screen by alternating every second between units of measure and the “H” alert, meaning High.



NOTE: The value of the High Temperature Alarm must be greater than the value of the Low Temperature Alarm.

### **d) Temperature Alarm Action Delay (Numerical entry)**

The Temperature Alarm Action Delay is a time period in seconds that the Temperature reading value may remain above the High limit or below the Low limit before an Alarm condition is activated. Valid settings are in the range of 0 to 3600 seconds. The default value is 0: no delay.

### **e) Temperature Alarm Power On Delay (Numerical entry)**

Sometimes it is convenient to enable the Temperature Alarm only after a specified power-up delay interval. The “**Temperature Alarm Power On Delay**” option allows the user to set a specified time interval that will have to elapse from the device power-up event before the Temperature Alarm function will be activated. Valid settings are in the range of 0 to 3600 seconds. The default value is 0: no delay.

### **f) Temperature Alarm Action Latch (Tabular entry)**

The Temperature Alarm Action Latch settings control the Latch feature. If SSR output is assigned to the Temperature Alarm Event, in some cases the Temperature Alarm Latch feature may be desirable.

Two settings are available: Disabled or Enabled. By default, the Temperature Alarm is non-latching. This means that the Alarm Action is indicated only if the monitored Temperature reading exceeds the user specified conditions.

### 6.4.13 Totalizer Settings

The DPC provides the user with two independent Programmable Flow Totalizers. The total volume (mass) of the flowing fluid is calculated by integrating the actual instantaneous fluid mass flow rate with respect to time. Totalizer reading values are stored in the EEPROM and saved every second. In the case of power interruption, the last saved Totalizer value will be loaded at the next power on cycle, so the Totalizer reading will not be lost. Use the “**Totalizer Menu**” to navigate to the “**Totalizer #1**” or “**Totalizer #2**” menu options. The following settings are available for Totalizer #1 and Totalizer #2 (see **Figure 19**):

#### a) Totalizer Mode (Tabular entry)

This option determines whether Totalizer is Enabled or Disabled, the only two selections available. The default entry is Disabled. Totalizer Mode selections can be set with the joystick **UP** and **DN** buttons and are accepted by pressing the joystick equivalent of an **ENT** button.



NOTE: Before enabling the Totalizer, ensure that all Totalizer settings are configured properly. Totalizer Start values must be entered in the currently active Volumetric or Mass flow engineering unit. The Totalizer will not totalize until the Process Flow Rate becomes equal to or greater than the Totalizer Start value. Totalizer Event values must also be entered in currently active volume- or mass-based engineering units. If the Totalizer Event (action) is not required at a preset total volume feature, set the Totalizer Event value to zero (which is the default setting).

#### b) Totalizer Flow Start (Numerical entry)

This option allows the start of the Totalizer at a preset flow rate. The Totalizer will not totalize until the process flow rate becomes equal to or greater than the Totalizer Flow Start value. The limit of required Totalizer Flow Start value can be entered in increments of 0.1%, from 0 - 100% FS.

#### c) Totalizer Action Volume (Numerical entry)

This option allows the user to activate a preset required action when the Totalizer reaches a preset volume. Totalizer Action Volume value must be entered in currently active volume- / mass-based engineering units. A Totalizer Action Event becomes true when the Totalizer reading is more than or equal to the preset “**Totalizer Action Volume**”. If the Totalizer feature is not required, set “**Totalizer Action Volume**” value to zero; this is the default setting.

#### d) Totalizer Power On Delay (Numerical entry)

Sometimes it is convenient to start the Totalizer only after a specified power-up delay interval. Mass flow controllers require some warm-up time from the power-up event in order to stabilize the process variable output and to get an accurate reading. The “**Totalizer Power On Delay**” option allows the user specify and set a time interval which must elapse from the device power-up event before the Totalizer will be activated. Valid settings are in the range of 0 to 3600 seconds. The default value is 0: no delay.

**e) Totalizer Auto Reset (Tabular entry)**

This option allows the automatic reset of the Totalizer when it reaches a preset Action Volume value. This feature may be convenient for batch processing, when a predefined volume of fluid must be repeatedly dispensed into the process. Two selections are available: Enabled or Disabled. The default entry is Disabled. Totalizer Auto Reset selections can be set with the joystick **UP** and **DN** buttons and are accepted by pressing the joystick equivalent of an **ENT** button.

**f) Totalizer Auto Reset Delay (Numerical entry)**

This option may be desirable when the “**Totalizer Auto Reset**” feature is enabled and a predefined delay is required before a new batch cycle starts. Valid settings are in the range of 0 to 3600 seconds. The default value is 0: no delay.

**g) Reset Totalizer (Tabular entry)**

Either Totalizer’s reading can be reset by selecting the “**Reset Totalizer**” menu option. A typical Totalizer Reset screen is shown below:



**Figure 31:** Reset Totalizer Screen

When the “**YES**” option is selected, Totalizer #1 will be reset. A confirmation screen will appear (see **Figure 32**).

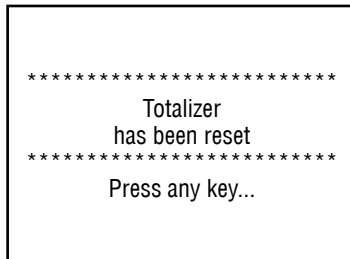

**Figure 32:** Totalizer Reset Confirmation

A local maintenance push button is available to manually reset the Totalizer in the field for DPC controllers without the OLED/joystick option. The maintenance push button is located on the left side of the instrument (see Section 6.5 “**Multi-Functional Push-Button Operation**”).



NOTE: If the Totalizer “**Lock Reset Function**” is enabled, the Reset feature is not functional and therefore the Totalizer cannot be reset. “**Lock Reset Function**” parameter can only be changed manually using supplied “**DPCM Configuration Utility**” software from “**Terminal**” mode using ASCII “T” command with “L” argument (see ASCII Command Set in Section 9.2). By default, the Totalizer “**Lock Reset Function**” is disabled, but it can be enabled by the user if the Totalizer reading in the user application must be preserved for the lifetime of the instrument.

#### **h) Totalizer Reading Decimal Point (DP) Precision (Numerical Entry)**

Sometimes it is convenient to have Totalizer reading decimal point precision much lower than Flow Rate readings (for example, when the Totalizer accumulates readings over a long period of time). The “**Totalizer DP Precision**” parameter allows the user to decrease the number of digits after the decimal point for Totalizer readings from 0 to -5. For example, if the Flow Reading has precision of 3 digits after the decimal point, setting the “**Totalizer DP Precision**” parameter to -2 will result in Totalizer reading precision of 1 digit after the decimal point. Fewer digits after the decimal point allow for more digits in front of it. Totalizer reading field has 10 digits.

#### **i) Totalizer Over Limit Action (Tabular entry)**

In some applications it may be required to stop gas flow when the Totalizer reaches a preset volume. In this case “**Totalizer Over Limit Action**” can be activated. This menu selection has two available options: **Disabled** and **Valve Close**. When assigned to “**Valve Close**” and the Totalizer reaches a preset volume the instrument control valve will be de-energized (Closed).

### **6.4.14 Submenu “Pulse Output”**

The flow Pulse Output operates independently from the Totalizers and is based on configuration settings (see **Figure 19**) which can provide pulse frequency proportional to instantaneous fluid mass flow rate.

The OLED/joystick interface and digital communication interface commands are provided to:

- Enable/Disable Pulse Output
- Start Pulse Output at a preset flow rate (0.0 - 100.0% FS)
- Configure Unit/Pulse value (in current engineering units)
- Configure Pulse Active On Time (50 - 6553 ms)



NOTE: The Pulse Output minimum Active On time is 50 milliseconds (0.05 second). The Pulse Output cannot operate faster than one pulse every 100 milliseconds (0.1 second). A good rule to follow is to set the Unit/Pulse value equal to the maximum flow in the same units per second. This will limit the pulse rate to no faster than one pulse every second.

For example:

Maximum flow rate = 120 gr/min (120 gr/min = 2 gr/sec)

If unit per pulse is set to 120 gr per pulse, the Pulse Output will pulse once every minute.

If unit per pulse is set to 2 gr per pulse, the Pulse Output will pulse once every second.

The Pulse Output incorporates the pulse output queue, which accumulates pulses if the Pulse Output is accumulating process flow faster than the pulse output hardware can produce. The queue will allow the pulses to “catch up” later if the flow rate decreases. A better practice is to slow down the Pulse Output by increasing the value in the Unit/Pulse setting in the Pulse Output menu (see **Figure 19**).



NOTE: If Pulse Output feature is required, the Solid State Relay (SSR) output must be assigned to the “**Pulse Output**” function (see Section 6.4.15.6). The Pulse output signal will be accessible via SSR output (pins 1 and 2) on the DPC 8-pin MiniDIN connector (see Figure 3 for proper wiring connections).

## **6.4.15 General Settings**

### **6.4.15.1 Valve Parameters**

For information related to Valve Parameters see **Section 6.4.3 Instrument Set Point and Valve Control**” on page 25.

### **6.4.15.2 STP / NPT Conditions**

This menu selection allows the user to set desired standard temperature and pressure conditions or normal temperature and pressure conditions. Following options are available in this menu selection:

**Standard Temperature**

**Standard Pressure**

**Normal Temperature**

**Normal Pressure**

Standard Temperature and Normal Temperature menu selections allow the user to first select desired temperature units of measure: °C, °F, °K, or °R. By default, currently active temperature units will be selected. Once the units are selected, the use can adjust the desired temperature value and press the joystick equivalent of an **ENT** button to save it. By default, currently stored values will be displayed.





NOTE: The factory default value for the Standard Temperature is 70 °F (21.1 °C), and for Normal Temperature is 32 °F ( 0.0 °C).

Standard Pressure and Normal Pressure menu selections allow the user to first select the desired pressure units of measure. By default, currently active pressure units will be selected. Once the units are selected, the user can adjust the desired pressure value and then press the joystick equivalent of an **ENT** button to save it. By default, currently stored values will be displayed.



NOTE: The factory default value for both Standard and Normal Pressure is 14.696 PSIA (1.0 atm).

Once Standard Temperature/Pressure and/or Normal Temperature/Pressure values are changed, the corresponding PI mass flow readings shown on the instrument display or transmitted via digital or analog interface will change as well.

### **6.4.15.3 Display and Process Information (PI) Screens**

The local OLED Process Information screens can be configured to be static (manual control) or dynamic (automatic sequencing). In the static mode, pressing the joystick UP allows the user to page through the PI screens in the forward direction, while pressing the joystick DN pages through the PI screens in the opposite direction. When the last PI screen is reached, the firmware “wraps around” and scrolls to the initial PI screen once again.



NOTE: PI screens which are not Enabled (masked) will be skipped. PI Screen #1 (Mass Flow Rate, Pressure, Temperature and Set Point reading) cannot be Disabled.

The following settings are available for OLED Display:

#### **a) Display Mode**

This option determines whether the display screens are in static (manual control) or dynamic (automatic sequencing) mode. Two selections are available: Static or Dynamic. The default entry is Static (manual control).

#### **b) Screen Cycle Time**

This menu selection defines the time interval in seconds for each PI screen to be displayed in the dynamic mode (automatic sequencing). Screen Cycle Time can be set to any value between 1 and 3600 seconds (numerical entry).

### c) PI Screen Configuration

Using Screen Configuration settings, the user can enable (unmask) or disable (mask) up to 8 different process variable combinations (see **Figure 33**). The screen is Enabled if the checkbox on the same line as the corresponding screen is selected: [\*]. If the screen is disabled, it will be skipped. By default, the instrument is shipped from the factory with all PI screens enabled, as indicated in **Figure 33**.

PI Screen Config:	
Screen #1	[*]
Screen #2	[*]
Screen #3	[*]
Screen #4	[*]
Screen #5	[*]
Screen #6	[*]
Screen #7	[*]

**Figure 33:** PI Screen Configuration

As explained, in the example shown above, all PI screens are enabled. Each PI screen is assigned to a corresponding bit in the PI Screen Register. In order to change PI Screen Configuration, the user should select the desired screen using the joystick **UP** and **DN** buttons and then press the **RIGHT** button. The asterisk will appear or disappear on the right side of the corresponding screen line. The asterisk signifies that the screen is enabled. In order to disable the screen, the corresponding asterisk must be removed. To accept and save new PI Screen Configuration settings in the device's nonvolatile memory, press the joystick **ENT** button.

### d) OLED Operational Brightness (Numerical entry)

Using OLED Operational Brightness settings, the user can adjust the desired level of OLED brightness during normal operation (when the screensaver is not active). The OLED brightness has 256 different levels.



NOTE: By default, the brightness level is set to 127 which is the optimal level for room temperature (20 °C or 70 °F).

### e) OLED Screensaver Mode

OLED is subject to burn-in. It can retain images on the screen temporarily and, in some cases even permanently if it is left static for too long. In order to mitigate this potential problem, the screensaver feature is provided.

This feature has 4 different modes:

- Disabled (no screensaver)
- Low Brightness
- Vertical Scrolling (default)
- OLED Off

#### f ) OLED Screensaver (SS) Time Out Feature (Numerical entry)

This menu selection defines a time interval in seconds from the moment the local Esc button or joystick interface was last used (or, if neither was used, from the power up event) to the moment the Screensaver is activated. Each time the user activates the local Esc button or the joystick interface, the OLED brightness reverts to normal “**Operational Brightness Level**” and the internal timer resets to zero, starting a new delay cycle. The default setting is 900 seconds (15 minutes).

#### g) OLED Screen Saver Brightness (Numerical entry)

Using OLED Screen Saver Brightness settings, the user can adjust the desired level of the OLED brightness during “**Low Brightness**” screensaver mode (when the screen saver is active). The brightness has 127 different levels.



NOTE: If Screensaver mode is active and has been changed, new settings will be activated in the next Screensaver cycle (after the Esc button or joystick interface was activated to disable the currently active screensaver). The OLED “**Screensaver Brightness Level**” parameter is only applicable for “**Low Brightness**” Screensaver mode. In “**Vertical Scrolling**” mode, the normal operational brightness level will be activated. If OLED display is not used in the user application (e.g., the instrument is installed in a remote enclosure), we recommend setting the Screensaver mode to “**OLED Off**”.

#### h) Flow Rate Precision (Tabular entry)

The DPC Flow Controller calculates Flow Rate Precision automatically, based on selected units of measure and current gas full scale flow rate to keep best reading precision. By default, the Flow Rate Precision is set to “**Normal**”. In cases where more digits after the decimal point are required, the user can change decimal point precision to the “**Elevated**” level (one more digit after the decimal point).



NOTE: In some cases, selecting “**Elevated**” precision may result in unstable readings (the last digit constantly changes). In such cases, we recommend switching the decimal point precision to the “**Normal**” level.

### 6.4.15.4 Submenu “Communication Port Settings”

This menu selection allows the configuration of a main digital communication interface type (RS-232 or RS-485), speed (Baud rate) and device RS-485 bus address and termination mode (only applicable for RS-485 interface).

The following settings are available for “**Communication Settings**” (see **Figure 19**):

### **a) UART Transceiver Mode (Tabular entry)**

The DPC instrument is equipped with a universal transceiver which supports both RS-232 and RS-485 interfaces. The following settings are available:

- Disabled
- RS-232
- RS-484



NOTE: The instrument is shipped from the factory with the communication interface type set according to your order.

Connecting the instrument to the wrong communication interface may cause damage or result in faulty operation of the electronics circuitry.

Before changing the communication interface type, make sure that the host device (PC or PLC) has the same interface type.

### **b) Baud Rate Settings (Tabular entry)**

This option determines the device's digital communication interface speed (Baud rate). It can be set to one of the following:

- 1200
- 2400
- 4800
- 9600
- 19200
- 38400
- 57600
- 115200

By default, the device is shipped from the factory with its baud rate set to 9600.



NOTE: The baud rate set on the DPC controller should always match the baud rate of the host PC and/or PLC that it is connected to.

### **c) RS-485 Bus Address (Numerical entry)**

The RS-232 interface does not require bus addressing. The RS-485 interface, however, does require 2 hexadecimal characters of the address to be assigned. By default, each instrument is shipped with its RS-485 address set to 11 hexadecimal. When more than one device is present on the RS-485, each device must have a unique address. The 2 characters of the address in the hexadecimal representation can be changed from 01 to FF.



NOTE: Address 00 is reserved for global addressing. Do not assign the global address to any device. When a command with the global address is sent, all devices on the RS-485 bus execute the command but do not reply with an acknowledgement message.

Do not assign the same RS-485 address for two or more devices on the same RS-485 bus. If two or more devices with the same address are connected to one RS-485 network, a communication collision will take place on the bus, causing communication errors to occur.

#### d) RS-485 Termination (applicable to RS-485 only)

A reflection in a transmission line is the result of an impedance discontinuity that a traveling wave sees as it propagates down the line. To minimize such reflections from the ends of the RS-485 cable, the user must place a Line Termination (LT) near each of the two ends of the RS-485 bus. If you are connecting a DPC controller as the last device in the end of a long (more than 100 meters) transmission line, you can use this menu selection to internally connect a 120Ω resistor between the RS-485 + and – wires.



NOTE: Do not Enable Termination if the transceiver is set to RS-232 mode. Doing so will cause damage to the instrument or improper operation of the communication interface. The factory default setting is Disabled.

### 6.4.15.5 Submenu “Modbus Interface” (optional)

If the DPC flow controller is equipped with Modbus interface, this menu selection allows the user to change the Modbus device ID (address) and its communication parameters.

Modbus is a standard protocol developed by A.E.G. Schnieder. The DPC supports only the Modbus RTU version. Modbus RTU enable a computer or a PLC to read and write directly to registers containing the instrument’s parameters (see technical document TD-DPMC-MOD-0118 “**Modbus RTU slave interface for AALBORG digital mass flow instruments**” for a detailed description of supported Modbus functions and registers).

The following parameters are available for “**Modbus Settings**” (see **Figure 19**):

#### a) Device ID (Address) (Numerical entry)

Decimal representation ranges from 1 to 247. By default, all DPC controllers are equipped with a Modbus interface shipped from the factory with the Device ID parameter set to decimal 11.



NOTE: Do not assign the same ID address for two or more devices on the same Modbus segment. If two or more devices with the same address are connected to the one Modbus network, a communication collision will take place on the bus, resulting in communication errors.

### **b) Baud Rate Settings (Tabular entry)**

This option determines the device's Modbus interface speed (Baud rate). It can be set to one of the following:

- 2400
- 4800
- 9600
- 19200
- 38400
- 57600
- 115200

By default, the device is shipped from the factory with its baud rate set at 9600.



NOTE: If multiple instruments are connected to the Modbus Master controller device, they all should have the same baud rate settings as the Master.

### **c) Modbus Communication Parity (Tabular entry)**

This parameter can be set to either None, Odd, or Even. By default, the Parity parameter is set to None. In real applications, this parameter should follow Parity settings used in the Modbus Master controller.

### **d) Modbus Communication Stop Bit (Tabular entry)**

This parameter can be set to either One (1) or Two (2). By default, the Stop Bit parameter is set to 2. In real applications, this parameter should follow Stop Bit settings used in the Modbus Master controller.

### 6.4.15.6 Relay Assignment

One set of the SPST Solid State Relay (SSR) outputs is provided to actuate user-supplied equipment. It is programmable via digital interface or local OLED/joystick interface such that the relay can be made to switch when a specified event occurs (e.g., when a low or high flow alarm limit is exceeded or when one of the two totalizers reaches a specified value).

The user can configure relay action from the following 16 options:

- Disabled:** No action (output is not assigned to any events and relay is not energized)
- Low Flow Alarm:** (L) Low Flow Alarm condition.
- High Flow Alarm:** (H) High Flow Alarm condition.
- Range between H&L:** (R) Range between High and Low Flow Alarm conditions.
- Low P. Alarm:** (L) Low Pressure Alarm condition.
- High P. Alarm:** (H) High Pressure Alarm condition.
- P. Range H-L:** (R) Range between High and Low Pressure Alarm conditions
- Low T. Alarm:** (L) Low Temperature Alarm condition.
- High T. Alarm:** (H) High Temperature Alarm condition.
- T. Range H-L:** (R) Range between High and Low Temperature Alarm conditions.
- Totalizer#1 > Limit:** (T1) Totalizer#1 exceeded preset limit volume.
- Totalizer#2 > Limit:** (T2) Totalizer#2 exceeded preset limit volume.
- Pulse Output:** Pulse Output Queue is overloaded.
- Alarm Events:** One or more Alarm Events are active.
- Diagnostic Events:** One or more Diagnostic Events are active.
- Manual On (Enabled):** (M) Activated regardless of the Alarm, Totalizers or other conditions. By default, relay is Disabled (not energized).



NOTE: Relay terminals are accessible via the DPC controller's 8-pin MiniDIN connector (pins 1 and 2) and have maximum 48VDC voltage and 0.4A current ratings. See Figure 3 and Table I for proper wiring connections.

### 6.4.15.7 Analog Output Configuration

The DPC series Mass Flow Controllers are equipped with calibrated 0-5Vdc, 0-10Vdc, and 4-20 mA output signals. The following options are provided for analog output:

#### a) Analog Output Mode (Tabular entry)

The user can select one of the following:

- 0-5 Vdc (3000 $\Omega$  minimum load impedance)
- 0-10 Vdc (5000 $\Omega$  minimum load impedance)
- 4-20 mA (sourcing type, 500 $\Omega$  maximum current loop resistance)



NOTE: Before changing “**Analog Output Interface**” mode, make sure the load impedance is within the corresponding limits stated above. Failure to do so might cause damage to the analog output circuitry or result in erroneous readings.



**CAUTION: The 4-20 mA current loop output is self-powered (sourcing non-isolated type). Do NOT connect an external voltage source to the output signals. (See Section 3.3 for proper wiring connections.)**

#### b) Analog Output Calibration

The DPC analog output calibration involves calculation and storing the offset and span variables in the EEPROM based on two calibration points (0 and 100% F.S.). The 0-5 and 0-10 outputs have only scale variables, and the 4-20 mA output has offset and scale variables.



NOTE: The analog outputs available in the DPC controller were calibrated at the factory. There is no need to perform analog output calibration unless the analog to digital converter (DAC) IC, output amplifier IC, or passive components from analog output circuitries were replaced or your factory customer support representative suggested recalibration. Any alteration of the analog output scaling variables in the EEPROM will void the calibration warranty supplied with the instrument.



Power up the DPC controller for at least 30 minutes prior to commencing the calibration procedure. Observe the current analog output mode settings.

**For 0-5 or 0-10 Vdc output calibration:**

**Connect the corresponding type of measurement device (voltmeter) to pins 6 (plus) and 4 (minus) of the 8-pin MiniDIN connector.**

**For 4-20 mA output calibration:**

**Connect the corresponding type of measurement device (ammeter) to pins 6 (plus) and 4 (minus) of the 8-pin MiniDIN connector.**

Follow firmware prompts and adjust calibration point values according to your measurement device reading by use of the joystick **UP**, **DN**, **LEFT** and **RIGHT** buttons. If you need to abort calibration, press the **Esc** button. When the calibration is complete, the firmware will display new offset and span values and ask the user to press the joystick **ENT** button to save the new calibration variables to the EEPROM, or to press the **Esc** button to abort calibration and exit without saving any changes. When the process is done, the firmware will prompt the user with a confirmation message.

**c) Analog Output Test**

This menu selection must be used only for troubleshooting purposes as requested by your customer support representative. It allows for emulating analog output readings by entering a desired flow rate reading in % of full scale, from 0.0 to 110.0%.



**CAUTION: When “Analog Output Test” is selected, the output reading does not represent any actual Process Information (PI) variable (flow rate reading).**

Adjust the desired flow output value using the joystick **UP**, **DN**, **LEFT** and **RIGHT** buttons. Press the joystick **ENT** button to activate analog output. To abort the analog output test mode, press the Esc button. Once the test mode is deactivated, the analog output should represent actual flow rate readings.

### **6.4.15.8 Analog Input Configuration**

The DPC series Mass Flow Controllers are equipped with calibrated 0-5Vdc, 0-10Vdc, and 4-20 mA set point input signals. The following options are provided for analog input:

**a) Analog Input Mode (Tabular entry)**

The user can select one of the following:

- 0-5 Vdc (100K input impedance)
- 0-10 Vdc (100K input impedance)
- 4-20 mA (250 Ohm input impedance)

## b) Analog Input Calibration

The DPC analog input calibration involves calculation and storing the offset and span variables in the EEPROM based on two calibration points (0 and 100% F.S.). The 0-5, 0-10 and the 4-20 mA inputs require scale and offset variables to be calculated based on the applied calibration signals.



**NOTE:** The analog inputs available in the DPC controller were calibrated at the factory. There is no need to perform analog input calibration unless the analog to digital converter (ADC) IC, input amplifier IC, or passive components from analog input circuitries were replaced or your factory customer support representative suggested recalibration. Any alteration of the analog input scaling variables in the EEPROM will void the calibration warranty supplied with the instrument.

Power up the DPC controller for at least 30 minutes prior to commencing the calibration procedure. Observe the current analog input mode settings.

Connect the corresponding type of reference signal source device (voltage source for 0-5 or 0-10 Vdc input calibration, and current source for 4-20 mA calibration) to pins 3 (plus) and 4 (minus) of the 8-pin MiniDIN connector.

Apply required signals levels according to firmware prompts and confirm it by pressing **Ent** joystick button. If you need to abort calibration, press the **Esc** button. When the calibration is complete, the firmware will display new offset and span values and ask the user to press the joystick **ENT** button to save the new calibration variables to the EEPROM, or to press the **Esc** button to abort calibration and exit without saving any changes. When the process is done, the firmware will prompt the user with a confirmation message.

## c) Analog Input Test

This menu selection must be used only for troubleshooting purposes as requested by your customer support representative. It allows monitoring analog set point input values (in % of full scale) by applying a different signals to instruments input terminals (pins 3 (plus) and 4 (minus) of the 8-pin MiniDIN connector).



**CAUTION:** Do not apply voltages above 12Vdc to the instrument analog input terminals. Doing so might cause damage to the analog input circuitry or result in erroneous readings.

## 6.4.15.9 Status LED Settings

DPC series Mass Flow Controllers are equipped with dual color LED which allows signaling a variety of different events with combinations of three colors (red, green and amber) and a specific time pattern. Status LED operation can be adjusted/ filtered for the indication of different events based on custom user needs.

Status LED can be set to the following modes (**see Figure 19**):

**1. Normal, which supports the following events:**

- 1.1 Auto Zero Failure (constant RED)
- 1.2 Fatal Error (constant RED, requiring the system to be reset for recovery)
- 1.3 User entry via side Push Button (specific pattern limited by a time interval up to 35 seconds)
- 1.4 Power Up Instrument Warm Up interval (1 to 3 seconds). (Constant AMBER). This can be interrupted only by User PB entry or Fatal Error.

**2. Monitoring Flow Alarm and Flow Totalizer events (default settings):**

- 2.1 High Flow Alarm RED/OFF (alternating every second).
- 2.2 Low Flow Alarm GREEN/OFF (alternating every second).
- 2.3 Totalizer#1 Event AMBER/OFF (alternating every second).
- 2.4 Totalizer#2 Event AMBER/OFF (alternating every second).
- 2.5 High Flow Alarm and Totalizer#1 Event RED/AMBER (alternating every second).
- 2.6 High Flow Alarm and Totalizer#2 Event RED/AMBER (alternating every 2 seconds)
- 2.7 Low Flow Alarm and Totalizer#1 Event GREEN/AMBER (alternating every second).
- 2.8 Low Flow Alarm and Totalizer#2 Event GREEN/AMBER (alternating every 2 seconds).
- 2.9 Both Totalizer#1 and Totalizer#2 Events AMBER/OFF (on for 3 seconds, off for 1 second).
- 2.10 High Flow Alarm and Totalizer#1 & #2 Events AMBER/RED (AMBER for 3 seconds, RED for 1 second).
- 2.11 Low Flow Alarm and Totalizer#1 & #2 Events AMBER/GREEN (AMBER for 3 seconds, GREEN for 1 second).

**3. Monitoring Alarm Events only (any active Alarm event will trigger LED indication): GREEN/OFF (alternating every second).**

**4. Monitoring Diagnostic Events only (any active Diagnostic event will trigger LED indication): RED/OFF (alternating every second).**

**5. Test and Configuration Communication Interface Monitoring:**

- 5.1 Data Received (RX activity) RED LED flashing momentarily (about 200 ms or less).

- 5.2 Data Transmitted (TX activity) GREEN LED flashing momentarily (about 200 ms or less).

## 6. Modbus Communication Interface Monitoring (optional):

- 6.1 Data Received (RX activity) RED LED flashing momentarily (about 200 ms or less).
- 6.2 Data Transmitted (TX activity) GREEN LED flashing momentarily (about 200 ms or less).

### 6.4.15.10 Signal Conditioner Settings



**CAUTION: The signal conditioner parameters for your controller were set at the factory to maintain the best performance. Do not change Signal Conditioner parameters unless so instructed by your factory technical support representative. Consult the factory for more information.**

### 6.4.15.11 Program Set Point

The **Program Set Point** feature allows execution of custom, user-preset programs of up to sixteen steps. During execution of the program, the user can activate or deactivate the **LOOP** mode and pause program execution. Various flow configurations may be preprogrammed: ramping, pulsing, linearized increasing and/or decreasing of the flow. Before executing, the program should be entered in the program table in the format: SETPOINT [% F.S.] - TIME [sec.]. TIME means: time it takes for the value of the set point signal for the flow controller, to linearly approach the SETPOINT value (ramping). Following settings are available for “**Program Set Point**”:

#### a) Program Set Point Mode (Tabular Entry)

This function determines whether the Program **Set Point** is **Enabled** or **Disabled**. The following selections are available: **Enabled** or **Disabled**. The default entry is **Disabled**. Program **Set Point** Mode selections can be set with the joystick **UP** and **DN** commands and are accepted by pressing joystick **ENT** button.

#### b) Program Set Point Loop Mode (Tabular Entry)

This function determines whether the Program **Set Point Loop** is **Enabled** or **Disabled**. If **Loop** is enabled as the program reaches the last step it wraps around and again starts execution from the first enabled step. The following selections are available: **Enabled** or **Disabled**. The default entry is **Disabled**. Program **Set Point Loop Mode** selections can be set with the joystick **UP** and **DN** buttons and are accepted by pressing joystick **ENT** button.

#### c) Program Set Point Step Mask (Tabular Entry)

Using **PSP Steps Mask** settings the user can enable (unmask) or disable (mask) any step in the program. If the step is masked, the program will skip it and move to the next enabled step. By default the unit is shipped from the factory with all program

steps enabled (unmasked). A typical display with PSP Steps Mask selection is shown in Figure 34 below.

PSP Steps Masc:			
S01	0.0%	0s	[*]
S02	0.0%	10s	[*]
S03	25.0%	25s	[*]
S04	25.0%	10s	[*]
S05	50.0%	25s	[*]
S06	50.0%	10s	[*]
S07	25.0%	30s	[*]

**Figure 34:** PSP Steps Mask Configuration

In the example shown above, all PSP Steps are enabled. Each PSP Step assigned to a corresponding bit in the PSP Steps Register. In order to change PSP Step mask settings user should select desired Step using joystick **UP** or **DN** buttons and then press Joystick **RIGHT** button. The asterisk will appear/disappear on the right side of the corresponding Step. The asterisk represents that Step is enabled. In order to disable Step, the corresponding asterisk must be removed. Use joystick **ENT** button to accept and save new PSP Steps mask settings in device non-volatile memory.

**d) Program Set Point Steps Settings (Numerical Entry)**

By using PSP Steps Settings menu selection the user can assign required set point and time values for each step in the program. A typical display with PSP Steps Settings selection is shown in Figure 35 below.

PSP Steps Settings:			
S01	0.0%	0s	[*]
S02	0.0%	10s	[*]
S03	25.0%	25s	[*]
S04	25.0%	10s	[*]
S05	50.0%	25s	[*]
S06	50.0%	10s	[*]
S07	25.0%	30s	[*]

**Figure 35:** PSP Steps Settings

In the example shown above, Step 01 is selected. For each step there are two parameters: set point value in %F.S. and time interval in seconds. In order to change PSP Step settings user should select desired step using joystick **UP** and **DN** buttons and then press the Joystick **ENT** button. The cursor in the selected (highlighted) parameter will start flashing. Use **UP**, **DN**, **LEFT**, and **RIGHT** joystick buttons to adjust desired value. Then press joystick **ENT** button to accept and save the new PSP Step settings in the device's non-volatile memory.

To activate Program **Set Point** mode the following must be done:

1. Program **Set Point** mode must be Enabled (see Section 5.4.15.11 a).
2. Source must be set to PSP (see Section 6.4.3).
3. Program Loop parameter must be set to desired value (On/Off).
4. Program Run parameter must be set to “**On**” (default settings is Off).



NOTE: Before executing, the program should be entered in the program table (see Section 5.4.15.11 c).

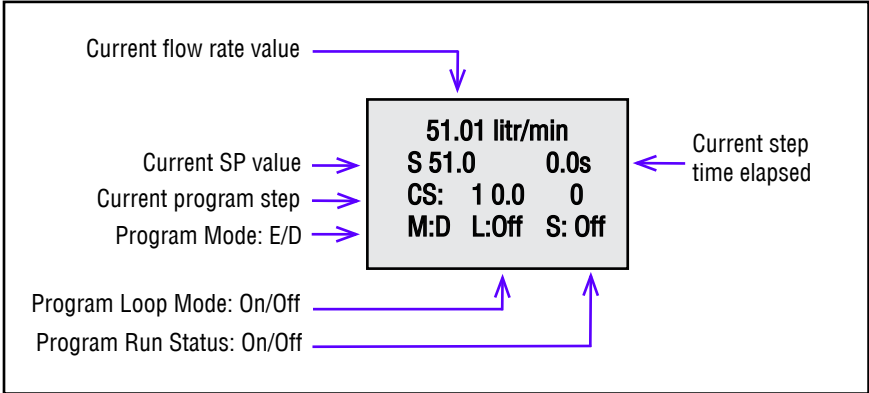

Figure 36: Instrument PI Screen #7 with PSP parameters

As shown in the Figure 36 above the Program Run Status parameter can be toggled “**On**” or “**Off**” by pressing the Joystick **LEFT** button, while PI screen #7 is active. If Program Run Status parameter is set to “**Off**”, the program execution will pause and current **Set Point** value will freeze until Program Run status parameter is set to “**On**”.

### 6.4.16 Sensor Zero Calibration

The DPC includes an auto zero function that, when activated, automatically adjusts the differential pressure sensors to read zero. The initial zero adjustment for your DPC was performed at the factory.

It is not required to perform zero calibration unless the device has zero reading offset with no flow conditions or the absolute pressure sensor reading is not accurate.



NOTE: Before performing Zero Calibration, make sure the device is powered up for at least 15 minutes and absolutely no flow condition is established. For better results, it is recommended that you start Auto Zero at least 30 minutes after power was applied to the instrument.

Shut off the gas flow into the DPC controller. Make sure the instrument **Valve Mode** is set to "**Closed**". To ensure that no seepage or leaking occurs into the device, it is good practice to temporarily disconnect the gas source. The Auto Zero may be initiated locally using optional OLED/joystick interface (see **Figure 19**) or by pressing the multi-functional maintenance push button located on the left side of the instrument, or via digital communication interface (see **Figure 59**: DPC Multi-functional Push Button).

### 6.4.16.1 DP Sensor Zero Calibration

To start DP sensor Auto Zero locally using OLED/joystick interface, navigate to "**Sensor Zero Calibration**" menu selection, then select "**Start Auto Zero Now**". On a DPC controller with optional OLED, the following screen will appear:

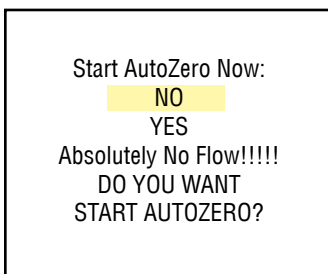

**Figure 37:** Start Sensor Auto Zero

To start Auto Zero, select the YES option and push the joystick **ENT** button. The status LED will start flashing RED/GREEN (alternating every 2 seconds). The following screen will appear:

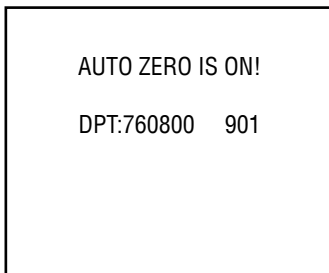

**Figure 38:** Sensor Auto Zero "On" Confirmation



**NOTE:** Actual differential pressure and temperature Analog to Digital Converter (ADC) counts readings for your instrument may be different.

Internal Auto Zero process may take 5 to 15 seconds.

If the DPC's digital signal processor was able to adjust the Sensor reading within  $0 \pm 7$  counts (within default Auto Zero Tolerance), the Auto Zero is considered successful.

The status LED will return to a constant GREEN light and the screen below will appear:

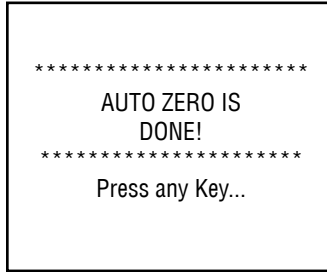

**Figure 39:** Sensor Auto Zero Completed

If the device was unable to adjust the sensor reading to within  $0 \pm 7$  counts, then Auto Zero is considered unsuccessful. A constant RED light will appear on the status LED. The user will be prompted with the “**Auto Zero ERROR!**” screen. If additional Auto Zero procedures yield the same error message, the sensor is most likely defective; arrange to return the instrument for service.



**NOTE:** To initiate Differential Pressure Sensor Auto Zero Calibration using the multifunctional maintenance push button, see Section 6.5.

#### **6.4.16.2 Start AP Auto Tare**

The DPC instrument is equipped with a high accuracy, high resolution absolute pressure sensor which was calibrated at the factory and does not require additional calibration. Depending on actual installation conditions, however, during operation it may periodically require the auto tare procedure to increase accuracy.



**CAUTION:** The AP Auto Tare procedure must be performed with absolutely no flow conditions. Make sure both inlet and outlet ports of the instrument are connected to the atmosphere.



**NOTE:** Before performing AP Auto Tare, make sure the device is powered for at least 15 minutes and absolutely no flow condition is established. For best results, we recommend starting AP Sensor Tare at least 30 minutes after power was applied to the instrument.

The AP Sensor Tare procedure requires high accuracy (at least 0.2% of reading) absolute pressure sensor reference standard. The AP sensor Tare result will be as accurate as your reference absolute pressure sensor is.



To start the AP sensor Tare procedure locally using the OLED/joystick interface, select “**Sensor Zero Calibration**” from the main menu, then navigate to the “**Start AP Auto Tare**” menu selection. The “**Start Absolute Pressure Sensor Tare**” screen will appear (see Figure 40).

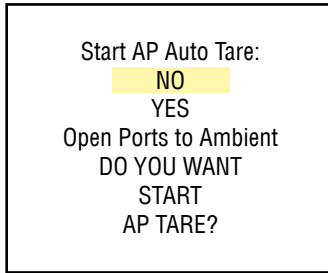

**Figure 40:** Start AP (Absolute Pressure) Sensor Tare

To start the Absolute Pressure sensor tare, select the “**YES**” option and push the joystick **ENT** button. The following screen will appear:

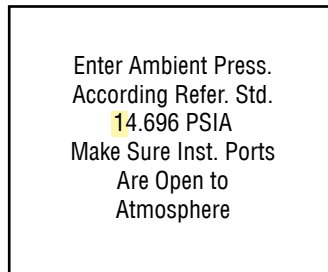

**Figure 41:** Entering Ambient Pressure from Reference Standard

Enter ambient pressure reading according to the reference standard. Once this is done, press the joystick **ENT** button. The instrument will perform an AP sensor tare process. If it is successful, the screen will prompt the user with a confirmation message.

#### **6.4.17 Submenu “Alarms and Diagnostic”**

The DPC is equipped with Alarm and Diagnostics Events registers. These are available via digital interface and an optional OLED screen indication. The Alarm Event Register monitors non-critical alarm events related to the instrument settings and process variables. The Diagnostic Event Register monitors critical diagnostic events related to instrument performance and peripheral hardware conditions.

### 6.4.17.1 Alarm Events Register

The following alarm events are supported:

TABLE XIX: ALARM EVENTS REGISTER		
EVENT NUMBER	ALARM EVENTS DESCRIPTION	OLED BIT CODE
1	High Flow Alarm	0
2	Low Flow Alarm	1
3	Flow Between High and Low Limits	2
4	Totalizer#1 Exceed Set Event Volume Limit	3
5	Totalizer#2 Exceed Set Event Volume Limit	4
6	High Pressure Alarm	5
7	Low Pressure Alarm	6
8	Pressure between High and Low Limits	7
9	Low Temperature Alarm	8
10	Low Temperature Alarm	9
11	Temperature Between High and Low Limits	A
12	Pulse Output Queue overflow	B
13	Password Event (attempt to change password)	C
14	Power On Event (power on delay > 0)	D

There are actually three separate registers:

- The Status Alarm Event Register, which holds each active alarm event (this is read only)
- The Mask Alarm Event Register, which allows the user to Enable or Disable monitoring for a particular event.
- The Latch Alarm Event Register, which allows the user to Enable or Disable the latch feature for a particular event.

#### a) Status Alarm Event Register (Read Only)

Each active Alarm Event will be indicated on the OLED screen. In addition, the total number of currently active alarm events will be displayed on the first line. A typical display with no active Alarm Events is shown in **Figure 42**.

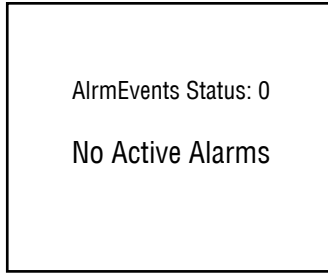

**Figure 42:** Alarm Events Register (with no alarms)

A typical display with two active Alarm Events is shown in **Figure 43:**

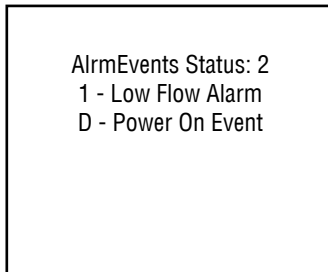

**Figure 43:** Alarm Events Register (with two active events)

If more than 7 events are displayed, the user can use the joystick **UP** and **DN** buttons to scroll through the record of all indicated events. If the event is not latched in the Latch Alarm Event Register, it may appear and disappear from the status screen; it will be indicated as long as the actual event is taking place.

#### **b) Mask Alarm Event Register (Tabular entry)**

Using the Mask Alarm Event Register settings, the user can individually enable (unmask) or disable (mask) each event. The event is enabled if an asterisk appears in the brackets to the right of the event name. If the event is disabled, it will not be processed or indicated in the events status Register even if actual conditions for the event have occurred. By default, the instrument is shipped from the factory with only one event active: **"8 – Power On Event"**. All other events are disabled. A typical display with Alarm Event Mask Register selection is shown in **Figure 44.**

Alarm Events Mask Reg:		
2 -	Range b/w H-L	[*]
3 -	Tot#1> Limit	[ ]
4 -	Tot#2> Limit	[ ]
5 -	High Press Alm	[ ]
6 -	Low Press Alm	[ ]
7 -	Prange b/w H-L	[ ]
8 -	High Temp Alm	[ ]

**Figure 44:** Alarm Events Mask Register

In the example shown in Figure 44, latch features for all except event #2 are disabled. In order to change the Mask Alarm Event Register settings, the user should select the desired event using the joystick **UP** and **DN** buttons, and then press the **RIGHT** button. The asterisk will appear in (or disappear from) the brackets to the right of the selected event. The asterisk indicates that the event is enabled. To disable an event, remove the corresponding asterisk. Use the **ENT** button to accept and save your new Mask Alarm Event Register settings to the controller's non-volatile memory.

### c) Latch Alarm Event Register (Tabular entry)

Using the Latch Alarm Event Register settings, the user can individually enable (unmask) or disable (mask) the latch feature for each event. The event latch is enabled if an asterisk appears in the brackets to the right of the event name. If the event is not latched (indicated by no asterisk), it may appear and disappear from the status screen. It will be indicated as long as the actual event is taking place. By default, the controller is shipped from the factory with the latch feature disabled for all events. A typical display with Latch Alarm Event Register selection is shown in **Figure 45**:

Alarm Events Latch Reg:		
2 -	Range b/w H-L	[*]
3 -	Tot#1> Limit	[ ]
4 -	Tot#2> Limit	[ ]
5 -	High Press Alm	[ ]
6 -	Low Press Alm	[ ]
7 -	Prange b/w H-L	[ ]
8 -	High Temp Alm	[ ]

**Figure 45:** Alarm Events Latch Register

In the Figure 45 example, latch features for all events are disabled except the Range between High and Low. In order to change Latch Alarm Register settings, the user should select the desired event using the joystick **UP** and **DN** buttons, then pressing the **RIGHT** button. The asterisk will appear in or disappear from the brackets to the right of the corresponding event. The asterisk means that the latch feature is enabled.

To disable a latch feature, the corresponding asterisk must be removed. Use the ENT button to accept and save new Latch Alarm Event Register settings in the controller's non-volatile memory.

**d) Reset Status Alarm Event Register (Tabular entry)**

The Status Alarm Event Register can be reset by selecting the “**Reset Alarm Event Reg**” menu option. A typical display with the Status Alarm Event Register reset screen is shown in Figure 46. Note that it requires confirmation from the user:

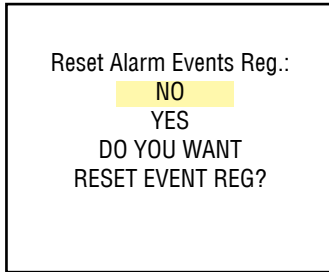

**Figure 46:** Resetting Alarm Events Register

Once the “**YES**” option is selected, the Event Register will be reset, and the following confirmation screen will appear:



**Figure 47:** Alarm Event Register Reset Confirmation



NOTE: Any Alarm Events that may have occurred (Event 0 to Event D) are stored in the internal status register. All detected events (if corresponding bit in the latch register is not masked) remain stored until the register is manually reset (by means of the digital communication interface). If the event corresponding bit in the latch register is masked (disabled), the event will be indicated as long as it is active (no latching). The status Alarm Event Register is mapped to the SRAM (volatile memory). In case of power interruption, the status Event Register will be automatically reset.

## 6.4.17.2 Diagnostic Events Register

The following alarm events are supported:

TABLE XX: DIAGNOSTIC EVENTS REGISTER		
EVENT NUMBER	DIAGNOSTIC EVENTS DESCRIPTION	OLED BIT CODE
1	CPU Temperature Too High	0
2	DP Sensor Initialization Error	1
3	AP Sensor Initialization Error	2
4	2.5 Vdc Reference Out of Range	3
5	Flow Out of Permissible Range	4
6	Absolute Pressure over Permissible Range	5
7	Gas Temperature Out of Range	6
8	Analog Output Alarm Flag	7
9	UART Serial Communication Error	8
10	Modbus Serial Communication Error	9
11	EEPROM R/W Error	A
12	Auto Zero Failure Flag	B
13	AP Tare Failure Flag	C
14	DP ADC Counts Invalid	D
15	AP ADC Counts Invalid	E
16	Fatal Error	F

**There are actually three separate registers:**

- The Status Diagnostic Event Register, which holds each active alarm event (this is read only).
- The Mask Diagnostic Event Register, which allows the user the Enable or Disable monitoring for a particular event.
- The Latch Diagnostic Event Register, which allows the user to Enable or Disable the latch feature for a particular event.

### **a) Status Diagnostic Event Register (Read Only)**

Each active Diagnostic Event will be indicated on the OLED screen. In addition, the total number of currently active events will be displayed on the first line. A typical display with no active Diagnostic Events is shown in **Figure 48**:

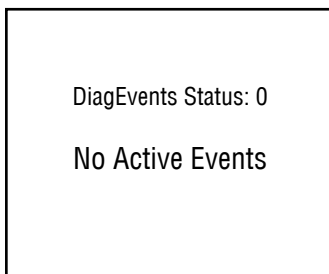

**Figure 48:** Diagnostic Events Status Register (no active events)

A typical display with two active Diagnostic events is shown below:

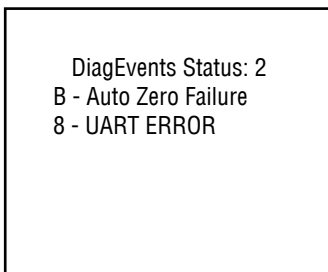
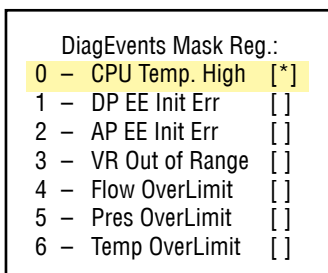

**Figure 49:** Diagnostic Events Status Register (two active events)

If more than 7 events are displayed, the user can scroll with the joystick **UP** and **DN** buttons to see all indicated events. If the event is not latched in the Latch Diagnostic Event Register, it may appear and disappear from the status screen; it will be indicated as long as the actual event is taking place.

### **b) Mask Diagnostic Event Register (Tabular entry)**

Using the Mask Diagnostic Event Register settings, the user can individually enable (unmask) or disable (mask) each event. The event is enabled if an asterisk appears in the brackets to the right of the event name. If the event is disabled (no asterisk), it will not be processed or indicated in the Events status Register, even if actual conditions for the event have occurred. By default, the instrument is shipped from the factory with only one event active: “**0 – CPU Temperature Too High**”. All other events are disabled. For a typical display with Mask Diagnostic Event Register selection, see **Figure 50**:



**Figure 50:** Diagnostic Events Mask Register

In the example shown above, latch features for all events except #0 are disabled. In order to change Mask Diagnostic Event Register settings, the user should select the desired event with the joystick **UP** and **DN** buttons, then press the **RIGHT** button. The asterisk will appear in or disappear from the brackets to the right of the selected event. The asterisk indicates that the event is enabled. Use the **ENT** button to accept and save the new Mask Diagnostic Event Register settings to the controller's non-volatile memory.

**c) Latch Diagnostic Event Register (Tabular entry)**

Using Latch Diagnostic Event Register settings the user can enable (unmask) or disable (mask) the latch feature individually for each event. An event is enabled (unmasked) when an asterisk appears in the brackets to the right of the corresponding event. When an event is not latched (no asterisk on the display), it may appear and disappear from the status screen. It will be indicated as long as the actual even takes place.

By default, the controller is shipped from the factory with the latch feature disabled for all events. A typical display with Latch Diagnostic Event Register selection is shown in **Figure 51**:

DiagEvents Latch Reg.:		
0	- CPU Temp. High	[*]
1	- DP EE Init Err	[ ]
2	- AP EE Init Err	[ ]
3	- VR Out of Range	[ ]
4	- Flow OverLimit	[ ]
5	- Pres OverLimit	[ ]
6	- Temp OverLimit	[ ]

**Figure 51:** Diagnostic Events Latch Register

In the example shown above, latch features for all but #0 are disabled. In order to change Latch Diagnostic Event Register settings, the user should select the desired event using the joystick **UP** and **DN** buttons, then press the **RIGHT** button. The asterisk will appear in or disappear from the brackets to the right of the corresponding event name. The asterisk indicates that the latch event is enabled. To disable an latch event, the corresponding asterisk must be removed. Use the **ENT** button to accept and save the new Latch Diagnostic Event Register settings in the controller's non-volatile memory.

**d) Reset Status Diagnostic Event Register (Tabular entry)**

The Status Diagnostic Event Register can be reset by selecting the **“Reset DiagEvents Reg.”** menu option. A typical display with the Status Diagnostic Event Register Reset screen is shown in **Figure 52**:



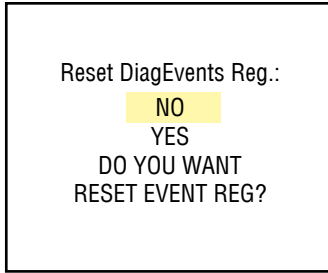

**Figure 52:** Resetting Diagnostic Events Register

When you select the “YES” option, the Event Register will be reset and the following confirmation screen will appear:



**Figure 53:** Confirmation of Diagnostic Events Register Reset

### 6.4.17.3 Sensors ADC Reading (read only)

This menu selection provides raw or average (filtered) values of the ADC counts for analog input circuitry troubleshooting in the different parts of the instrument (read only). A typical display with ADC Input Counts screen is shown below:

D: 171825	171841
DP: 171786	970
A:-397962	-397961
AP:-397835	970

**Figure 54:** Pressure Sensors ADC



NOTE: Actual content of the ADC Diagnostic screen may vary depending on the model and device configuration. Consult your factory customer support representative for more details about ADC troubleshooting.

#### 6.4.17.4 Temperature Sensors Diagnostic (read only)

This menu selection provides raw or average (filtered) ADC counts for gas temperature and pressure sensor temperature readings, which may be useful for Digital Signal Processing (DSP) troubleshooting (read only). A typical display with Temperature ADC Counts is shown in Figure 55:

GT: -5230	27589
T: 27594	26.98C
CPU:1726	34.1 C
DAT 30.47	30.41

**Figure 55:** Temperature Sensors Diagnostics



NOTE: Actual content of the ADC Diagnostic screen may vary depending on the model and device configuration. Consult your factory customer support representative for more details about ADC troubleshooting.

#### 6.4.17.5 Analog Output and PO Queue Diagnostic (read only)

This menu selection provides information about the controller's Analog Output settings and DAC counts, as well as Pulse Output (PO) Queue register value, which may be useful for Analog Output and PO circuitry troubleshooting (read only). A typical display with Analog Output and PO Queue values is shown in **Figure 56**:

A.Output:	4-20mA
DAC Upd:	Enabled
DAC Counts:	34881
PO Queue:	0/100

**Figure 56:** Analog Output and PO Queue Diagnostic



NOTE: Actual content of the Analog Output and PO Queue Diagnostic screen may vary depending on the model, device configuration, and controller operational state. Consult your factory customer support representative for more details about Analog Output and PO troubleshooting.

### 6.4.17.6 Solenoid Valve Parameters Diagnostic

P:0.0030	1.3500
I:0.0000	B:0.1221
D:0.040	E:0.2499
V:1.00000	0

**Figure 57:** Solenoid Valve Parameters Diagnostic

This menu selection provides information about valve **PID** and control loop parameters. Consult your factory customer support representative for more details about Solenoid Valve Parameters Diagnostic.

### 6.4.17.7 Reference Voltage and DSP Calculation Diagnostic (read only)

This menu selection provides information about current 2.5Vdc reference voltage value as well as different parameters of the Temperature/Pressure Compensation Algorithm, which may be useful for controller troubleshooting (read only). A typical Reference Voltage and DSP Calculation diagnostic screen is shown in **Figure 58**:

REF: 3112	2.508
0.0001	14.7890
294.2611	300.151
VMCF:	0.985579

**Figure 58:** Reference Voltage and DSP Calculation Diagnostic



NOTE: Actual content of the Reference Voltage and DSP Diagnostic screen may vary depending on the model, device configuration, and controller operational state. Consult your factory customer support representative for more details about Reference Voltage and DSP Calculation troubleshooting.

## 6.5 Multi-Functional Push-Button Operation

The DPC provides the user with a micro push-button switch accessible via a small hole on the left side of the instrument (see Figure 59), which can be used to select/start some important actions for the instrument. The micro push-button switch functionality is available on all DPC models in both analog and digital operation mode.

Pressing a switch briefly (< 6 sec) will not cause unwanted actions but will provide the currently selected mode for this instrument's communication port. The response will be with one of three signals, as indicated below:

- 1 time AMBER flashing - "Communication Port Disabled"
- 2 times AMBER flashing - "RS-232"
- 3 times AMBER flashing - "RS-485"



**Figure 59:** DPC and Multi-Function Push-Button Access Hole

See Table XXI on the following page for explanations

**TABLE XXI: LED Indications using the Multi-Function Push-Button During Normal Running Mode**

STATUS LED INDICATION	TIME PUSHED	INSTRUMENT ACTION
Amber flashing On/Off every 2 seconds Com. Port Status: 1 – Port disabled 2 – RS-232 3 – RS-485	1-6 seconds	Pressing a switch briefly (<6 sec) will not cause unwanted actions from the device but will provide currently selected mode for Communication port, depending on the number of Amber flashing: 1 time Communication port disabled 2 times RS-232 3 times RS-485
Amber flashing On/Off every 2 seconds	6-12 seconds	Releasing the switch during this time will Reset the instrument. The instrument's program will be restarted, and all warning and error messages will be cleared. During start-up, the instrument will perform a self-test.
Green flashing On/Off every 2 seconds	12-18 seconds	Releasing the switch during this time will start the controller flow sensor Auto Zero Calibration. <b>NOTE: First make sure there is absolutely no flow and the controller has been connected to power for at least 15 minutes.</b>
Red constantly On: the user has <b>14 seconds</b> to select which Totalizer has to be reset or to toggle Communication port mode. The Com. Port toggle sequence is: Disable⇒RS-232 RS-232⇒RS-485 RS-485⇒Disabled	18-24 seconds	Releasing the switch during this time will switch the user push-button to Totalizers Reset Mode or Communication Interface Mode Change. The user can start push-button entry during the next 14 seconds, and then can select which Totalizer to reset or perform Communication Interface toggle action based on the number of times the push-button is pressed. When the push-button is pressed, in order to validate the single push, watch the Green LED turn On, and do not release the push button until the Green LED turns Off (approx. 2 seconds).
	2 seconds until the Green LED turns Off	Pressing the push-button once during the 14-second window will Reset Totalizer#1. When the push-button is released, the Red LED turns On (ready to be pressed).
	2 seconds until the Green LED turns Off	Pressing the push-button twice during the 14-second window will Reset Totalizer#2. When the push-button is released, the Red LED turns On (ready to be pressed).
	2 seconds until the Green LED turns Off	Pressing the push-button 3 times during the 14-second window will Reset Totalizer#1 and Totalizer#2.
	2 seconds until the Green LED turns Off	Pressing the push-button 4 times during the 14-second window will initiate single toggle action for Communication Interface. Each single toggle action performs the following change: Disabled ⇒RS-232 RS-232 ⇒RS-485 RS-485 ⇒Disabled



NOTE: If the user does not press the Push-Button within a 10-second timeframe or keep the push-button pressed for the required time (approximately 2 seconds or until Green LED turns Off), no action will take place. Push-Button entry will reset to the default state and the Green LED will be turned On.

## 7. MAINTENANCE

### 7.1 General

It is important that the DPC Mass Flow Controller be used only with clean, dry, non-corrosive filtered gases. Liquids may not be used. Since the restrictor flow element (RFE) consists of small stainless steel channels, it is prone to occlusion due to impediments of large particles or gas crystallization. Other flow passages are also easily obstructed.

Great care, therefore, must be exercised to avoid the introduction of any potential flow impediment. To protect the instrument, we recommend the use of in-line filters: 5 $\mu$  (DPC04/07), 20 $\mu$  (DPC14/17/37/47) or 50 $\mu$  (DPC57/67/77). There is no other maintenance required. It is good practice, however, to keep the controller away from vibration, hot corrosive environments, and excessive RF or magnetic interference. We recommend that instruments be returned to Aalborg® for repair service and calibration (see Section 1.3).



**CAUTION: TO PROTECT SERVICING PERSONNEL, IT IS MANDATORY THAT ANY INSTRUMENT BEING RETURNED FOR SERVICE HAS BEEN COMPLETELY PURGED AND NEUTRALIZED OF TOXIC, BACTERIOLOGICALLY INFECTED, CORROSIVE OR RADIOACTIVE CONTENTS.**

### 7.2 Cleaning

Before attempting any disassembly of the instrument for cleaning, we recommend inspecting the flow paths by looking into the inlet and outlet ends of the instrument for any debris that may be clogging the flow through the instrument. Remove debris as necessary. If the blockage still exists, contact Aalborg or your local distributor to arrange for repair or cleaning service.



**CAUTION: DISASSEMBLY MAY COMPROMISE CURRENT CALIBRATION. After RFE and flow paths cleaning, a recalibration is needed. Aalborg offers professional calibration support. Contact Aalborg or your local distributor for cleaning and recalibration options.**

## 8. RECALIBRATION

The recommended period for recalibration of the DPC flow controller is once annually.

Aalborg® Instruments' Flow Calibration Laboratory offers professional calibration support for Mass Flow Meters using NIST-traceable precision calibrators under strictly controlled conditions. NIST-traceable calibrations are available.



**CAUTION:** DPC flow controllers can be only calibrated by Aalborg Instruments' Flow Calibration Laboratory or an Aalborg authorized trained and certified calibration facility.

## 9 RS-235/RS-485 SOFTWARE INTERFACE COMMANDS

### 9.1 General

The standard DPC instrument comes with an RS-232 interface; an RS-485 interface is optional. For the RS-232 interface, the start character ! and two hexadecimal characters for the address must be omitted. The protocol described below allows for communications with the unit using either a custom software program or a “dumb terminal”. All values are sent as print ASCII characters.

For the RS-485 interface, the start character is always !. The command string is terminated with the equivalent of a carriage return; line feeds are automatically stripped out by the DPC. (See Section 3.4 for information regarding communication parameters and cable connections).

### 9.2 Commands Structure

The structure of the command string is as follows:

RS-485	!<Addr>,<Cmd>,Arg1,Arg2,Arg3,Arg4<CR>	Example: !11,F<CR>
RS-232	<Cmd>,Arg1,Arg2,Arg3,Arg4<CR>	Example: F<CR>

Where:

!Addr	Start character <b>** (must only be used for RS-485 option)</b> RS-485 device address in the ASCII representation of hexadecimal (00 through FF are valid). <b>** (must only be used for R-485 option).</b>
Cmd	The one- or two-character command (see examples below).
Arg1 to Arg4	The command arguments (see examples below). Multiple arguments are comma-delimited.
CR	Carriage Return character.



**NOTE:** The default RS-485 address for all units is 11. Never submit the start character with a two-character hexadecimal device address for the RS-232 option.

Several examples of commands are shown below. All assume that the DPC controller has been configured for decimal address 18 (12 hex) on the RS-485 bus:

1. To get currently selected Gas: !12,G<CR>  
The DPC will reply: !12,G:0,AIR<CR>  
(assuming the Current Gas is #0, calibrated for AIR)
2. To get current Flow Rate Alarm status:  
!12,FA,R<CR>  
The DPC will reply: !12,FAR:N<CR> (assuming no flow alarm conditions)
3. To get a mass and volumetric flow reading:  
!12,F<CR>  
The DPC will reply: !12,50.0,50.3<CR> (assuming the mass flow is at 50% FS)
4. Set the Set Point to 100.0 % full scale:  
!12,SP,100.0<CR>  
The DPC will reply: !12,SP:100.0<CR>
5. Set the High and Low Flow Alarm limit to 90% and 10% of Full Scale flow rate:  
!12,FA,C,90.0,10.0<CR>  
The DPC will reply: !12,90.00,10.00,<CR>



NOTE: Address 00 is reserved for global addressing. Do not assign the global address to any device. When commands with the global address are sent, all devices on the RS-485 bus execute the command but do not reply with an acknowledgement message.

The global address can be used to change RS-485 address for a particular device without local display and joystick interface with unknown address:

1. Make sure only one device (whose address must be changed) is connected to the RS-485 network.
2. Type the memory write command with the global address:  
!00,MW,118,XX,<CR>where XX, the new hexadecimal address, can be from 01 to FF.

After the new address has been assigned, a device will accept commands with the new address.



NOTE: Do not assign the same RS-485 address to two or more devices on the same RS-485 bus. If two or more devices with the same address are connected to one RS-485 network, a communication collision on the bus will result, leading to communication errors.



**TABLE XXII: AALBORG DPC ASCII SOFTWARE INTERFACE COMMANDS**

**Note: An “\*” indicates power up default settings.**

**An “\*\*” indicates optional feature not available on all models.**

COMMAND NAME	DESCRIPTION	No.	COMMAND SYNTAX					
			Command	Argument 1	Argument 2	Argument 3	Argument 4	Response
Flow	Requests the current mass and volumetric flow reading in current MEU and VEU	1	F	NO ARGUMENT (read only)				<M Value>, <V Value> (Actual mass and volumetric flow in current mass and volumetric engineering units)
Mass Flow	Requests the current mass flow reading in current MEU	2	FM	NO ARGUMENT (read only)				<M Value> (Actual mass flow in current mass engineering units)
Volumetric Flow	Requests the current volumetric flow reading in current VEU	3	FV	NO ARGUMENT (read only)				<V Value> (Actual volumetric flow in current mass engineering units)
Process Information (PI)	Read Process Information (PI) parameters: Mass Flow Rate (MEU) Volumetric Flow Rate (VEU) Totalizer#1 value (MEU) Totalizer#2 value (MEU) Gas Temperature (TEU) Gas Pressure (PEU) Flow Alarm Status [D,N,H,L] Temp. Alarm Status [D,N,H,L] Press. Alarm Status [D,N,H,L] Current status of the Alarm Events Register (Hex) Current status of Diagnostic Events Register (Hex) NOTE: See list of the Alarm and Diagnostic Events below.	4	PI	NO ARGUMENT (read only)				<MF>,<VF>,<Total#1 Value>,<Total#2 Value>,<Gas Temperature>,<Gas Pressure>,<Flow Alarm Status>,<Temp. Alarm Status>,<Press. Alarm Status>,<Alarm Events Register>,<Diagnostic Events Register> Example: 25 4 23 2 354 2 0 0 24 8, 14 95 D N D 0 X 0 0 x 0

COMMAND NAME	DESCRIPTION	No.	COMMAND SYNTAX					
			Command	Argument 1	Argument 2	Argument 3	Argument 4	Response
Alarm Events Registers	Read/Set/Reset value of Alarm Events Registers: Status Register: (Read/Reset) Mask Register: (R/W) Latch Register: (R/W)  See list of the Alarm Events below: 0 FLOW_ALARM_HIGH 0x0001 1 FLOW_ALARM_LOW 0x0002 2 FLOW_ALARM_RANGE 0x0004 3 TOTAL1_HIT_LIMIT 0x0008 4 TOTAL2_HIT_LIMIT 0x0010 5 PRES_ALARM_HIGH 0x0020 6 PRES_ALARM_LOW 0x0040 7 PRES_ALARM_RANGE 0x0080 8 TEMP_ALARM_HIGH 0x0100 9 TEMP_ALARM_LOW 0x0200 A TEMP_ALARM_RANGE 0x0400 B PULSE_OUT_QUEUE 0x0800 C PASSWORD_EVENT 0x1000 D POWER_ON_EVENT 0x2000	5	AE	NO ARGUMENT (read Alarm Events status register)  R (reset Alarm Events status register to 0x0000)  M (Read/Set Alarm Events Mask register)				AE:<Value> Example: AE:0x0  AER:0x0  AEM:0x1  AEM:0x11  AEL:0x1  AEL:0x11

COMMAND SYNTAX								
COMMAND NAME	DESCRIPTION	No.	Command	Argument 1	Argument 2	Argument 3	Argument 4	Response
Diagnostic Events Registers	<p>Read/Set/Reset current value of the Diagnostic Events Registers</p> <p>Status Register: (Read/Reset) Mask Register: (R/W) Latch Register: (R/W)</p> <p>See list of the Diagnostic Events below:</p> <p>0 CPU_TEMP_HIGH 0x0001 1 DP EE INIT ERROR 0x0002 2 AP EE INIT ERROR 0x0004 3 VREF_OUT_OF_RANGE 0x0008 4 FLOW ABOVE LIMIT 0x0010 5 AP OUT OF RANGE 0x0020 6 G TEMP OUT OF RANGE 0x0040 7 ANALOG OUT ALARM 0x0080 8 SER COMM FAILURE 0x0100 9 MB COMM FAILURE 0x0200 A EEPROM FAILURE 0x0400 B AUTOZERO FAILURE 0x0800 C AP TARE FAILURE 0x1000 D DP PRESSURE INVALID 0x2000 E AP PRESSURE INVALID 0x4000 F FATAL_ERROR 0x8000</p>	6	DE	<p>NO ARGUMENT (read Diagnostic Events status register)</p> <p>R (reset Diagnostic Events status register to 0x0000)</p> <p>M (Read/Set Diagnostic Events Mask register)</p> <p>L (Read/Set Diagnostic Events Latch register)</p>				<p>DE:&lt;Value&gt; Example: DE:0x0</p> <p>DER:0x0</p> <p>DEM:0x1</p> <p>DEM:0x101</p> <p>DEL:0x1</p> <p>DEL:0x101</p>

COMMAND NAME	DESCRIPTION	No.	COMMAND SYNTAX					
			Command	Argument 1	Argument 2	Argument 3	Argument 4	Response
Read Gas Temperature	Requests the Gas Temperature reading in current TEU	7	GT	NO ARGUMENT (read only)				<T Value> (Actual gas temperature in current temp. engineering units) Example: 24.51
Read Gas Pressure	Requests the Gas Pressure reading in current PEU	8	GP	NO ARGUMENT (read only)				<P Value> (Actual gas pressure in current pressure engineering units) Example: 14.66
Gas	Read / Select Active Gas Indexes:  NOTE: Instrument configured for non-corrosive gases support indexes 0 to 128 (see list of all supported gases).	9	G	NO ARGUMENT (read current active Gas index and Gas Name)				Example: G:0,AIR 0 – Gas Index AIR – Gas name
				<Value> [0-128] Select new Gas NOTE: Instruments w/o Corrosive Gases support only 129 gases [0-128]				Example: G:5,He 5 – Gas Index He – Gas name

COMMAND NAME	DESCRIPTION	No.	COMMAND SYNTAX					
			Command	Argument 1	Argument 2	Argument 3	Argument 4	Response
Device Info	Read device configuration info: - Currently selected Gas (index, name) - Full scale range (L/min) - Mass flow Units of measure - Volumetric flow Units of Measure - Totalizer#1 mode D – Disabled E – Enabled - Totalizer#2 mode D – Disabled E – Enabled - Analog Output Mode 0 – 0-5 Vdc 1 – 0-10 Vdc 2 – 4-20 mA - ModBus H/W status [0/1] 0 – Installed 1 – Not Installed	10	DI	NO ARGUMENT (Read Only)				DI:5, Helium, 0.200, Sml/min, ml/min, E, D, 0, 1  5 – Gas index 5(Helium) – full scale (L/min) Sml/min – current MEU ml/min – current VEU E – Totalizer#1 Enabled D – Totalizer#2 Disabled 0 – Analog Output set to 0-5 Vdc 1 – ModBus interface H/W is not installed (Not Supported)

COMMAND SYNTAX								
COMMAND NAME	DESCRIPTION	No.	Command	Argument 1	Argument 2	Argument 3	Argument 4	Response
Flow Alarms	<p>Sets / reads the parameters of the mass flow alarms.</p> <p>Controller Flow Alarm conditions:            Flow <math>\geq</math> High Limit = H            Flow <math>\leq</math> Low Limit = L            Low &lt; Flow &lt; High = N</p> <p>Alarm Settings Reply parameters:            M – mode (E/D)            Hv – High settings value            Lv – Low settings value            A – Action Delay (sec)            L – Latch mode (0-1)            P – Power Up delay (sec)</p> <p>Flow Alarm Valve actions:            0 - Disabled            1 - High Alarm            2 - Low Alarm</p>	11	FA	<p>C (set Mass Flow Alarm High and Low limits parameters)</p> <p>A (Flow Alarm action delay in sec.)</p> <p>E (enable flow alarm)</p> <p>D (disable flow alarm) *</p> <p>R (Read current status)</p> <p>S (Read current settings)</p> <p>P (Flow Alarm Power Up delay in sec.)</p> <p>L (Latch mode)</p> <p>V (Valve action)</p>	<p>&lt;Value&gt; (high limit, %FS.) [0.1 – 110.0] %FS.</p> <p>&lt;Value&gt; [0-3600]</p>	<p>&lt;Value&gt; (low limit, %FS.) [0.0 – 109.9] %FS.</p>	<p>FAA:&lt;Value&gt; Example: FAA:5</p> <p>FA:E</p> <p>FA:D</p> <p>FAR:NI (no alarm) FAR:H (high alarm) FAR:L (low alarm)</p> <p>FAS:M,Hv,Lv,A,L,P Example: FAS:E,40,00,20,00,2,0,8</p> <p>FAP:&lt;Value&gt; Example: FAP:60</p> <p>FAL:&lt;Value&gt; where: Value = 0 – 1 Example: FAL:0</p> <p>FAV:&lt;Value&gt; where: Value = 0 – 2 Example: FAV:0</p>	

COMMAND SYNTAX								
COMMAND NAME	DESCRIPTION	No.	Command	Argument 1	Argument 2	Argument 3	Argument 4	Response
Temperature Alarms	<p>Sets / reads the parameters of the temperature alarms.</p> <p><b>Note: High alarm value has to be more than Low alarm value.</b></p> <p>Device Temperature Alarm conditions:  Temp. <math>\geq</math> High Limit = H  Temp. <math>\leq</math> Low Limit = L  Low <math>&lt;</math> Temp. <math>&lt;</math> High = N</p> <p>Alarm Settings Reply parameters:  M – mode (E/D)  Hv – High settings value  Lv – Low settings value  A – Action Delay (sec)  L – Latch mode (0-1)  P – Power Up delay (sec)</p>	12	TA	<p>C (set Temp Alarm High and Low limits parameters)</p> <p>A (Temp Alarm action delay in sec.)</p> <p>E (enable Temp Alarm)</p> <p>D (disable temp alarm)*</p> <p>R (read current status)</p> <p>S (Read current settings)</p> <p>P (Temp Alarm Power Up delay in sec.)</p> <p>L (Latch mode)</p>	<p>&lt;Value&gt; (high limit, Kelvin.) [253.16 °K – 343.15 °K]</p> <p>&lt;Value&gt; [0-3600]</p>	<p>&lt;Value&gt; (low limit, Kelvin) [253.15°K – 343.14°K]</p>		<p>TAC:333.25,263.15</p> <p>TAA:&lt;Value&gt; Example: TAA:5</p> <p>TA:E</p> <p>TA:D</p> <p>TAR:H (high alarm) TAR:L (low alarm)</p> <p>TAS:M,Hv,Lv,A,L,P Example: TAS:E,333.25,263.15,2,0,10</p> <p>TAP:&lt;Value&gt; Example: TAP:60</p> <p>TAL:&lt;Value&gt; where: Value = 0 – 1 Example: TAL:0</p>

COMMAND SYNTAX								
COMMAND NAME	DESCRIPTION	No.	Command	Argument 1	Argument 2	Argument 3	Argument 4	Response
Pressure Alarms	<p>Sets / reads the parameters of the pressure alarms.</p> <p><b>Note: High alarm value has to be more than Low alarm value.</b></p> <p>Device Pressure Alarm conditions: Pressure <math>\geq</math> High Limit = H Pressure <math>\leq</math> Low Limit = L Low &lt; Pressure &lt; High = N</p> <p>Alarm Settings Reply parameters: M – mode (E/D) Hv – High settings value Lv – Low settings value A – Action Delay (sec) L – Latch mode (0-1) P – Power Up delay (sec)</p>	13	PA	C (set Press. Alarm High and Low limits parameters)	<Value> (high limit, PSIA) [0.1 –100.00] PSIA	<Value> (low limit, PSIA) [0.0 –90.99] PSIA		PAC:60.00,10.00
				A (Press. Alarm action delay in sec.)	<Value> [0-3600]			PAA:<Value> Example: PAA:5
				E (enable Press. Alarm)				PA:E
				D (disable Press. Alarm)*				PA:D
				R (read current status)				PAR:IN (no alarm) PAR:H (high alarm) PAR:L (low alarm)
				S (Read current settings)				PAS:M;Hv,Lv,A,L,P Example: PAS:E;60.00,10.0 0,2,0,5
				P (Pres. Alarm Power Up delay in sec.)	<Value> [0-3600]			PAP:<Value> Example: PAP:60
				L (Latch mode)	<Value> (0-disabled*) (1-enabled)			PAL:<Value> where: Value = 0 – 1 Example: PAL:0



COMMAND NAME	DESCRIPTION	No.	COMMAND SYNTAX					
			Command	Argument 1	Argument 2	Argument 3	Argument 4	Response
Relay Assignment	Read / Set SSR Relay Assignment D - no action (SSR disabled*) FL - Low flow alarm FH - High flow alarm FR - Range between High & Low flow alarms PL - Low pressure alarm PH - High pressure alarm PR - Range between High & Low pressure alarms TL - Low temperature alarm TH - High temperature alarm TR - Range between High & Low temperature alarms T1 - Tot#1 reading > limit T2 - Tot#2 reading > limit PO - Pulse Output AE - Alarm Events DE - Diagnostic Events M - Manual On (energized)	14	R					R:D R:FL R:FH R:FR R:PL R:PH R:PR R:TL R:TH R:TR R:T1 R:T2 R:PO R:AE R:DE R:M S (read current settings)

NOTE: when SSR is energized, the normally open contact is closed.

COMMAND SYNTAX											
COMMAND NAME	DESCRIPTION	No.	Command	Argument 1	Argument 2	Argument 3	Argument 4	Response			
Totalizers	Sets and controls action of the flow Totalizers.  NOTE: Start totalizer at Flow value has to be entered in %FS (0.0 – 100.0). Limit volume has to be entered in currently selected mass EU.  If Totalizer hit limit event is not required, set "Limit Volume" value (argument 4) to zero.  Totalizers support Count Up mode only.  I Auto Reset mode is Enabled the Totalizer volume will be reset to zero as soon as Totalizer reading reaches "Limit Volume" value.  Totalizers reading are stored in EEPROM (non volatile) memory. Power cycle will not affect Totalizers reading. In addition Totalizers reading are backed up in separate EEPROM partition with 6 minutes interval. In case of error Totalizers reading may be restored from backup location.  Totalizers cannot be reset if Reset Lock parameter value set to 1.	15	T	1 (Totalizer #1)	Z			T1Z or T2Z			
				2 (Totalizer #2)	(Reset to zero)						
					C – Start flow and Event Condition	<value> (start totalizer at flow) %FS [0.0 – 100.0]		<value> (Limit volume in current volume based EU)			T1C:2.5, 0.0 (limit not required) or T2C:2.0, 20580.5
					P – Power On Delay		<value> (0-3600 sec)				T1P: 10 or T2P:20
					D (disable totalizer)*						T1:D or T2:D
					E (enable totalizer)						T1:E or T2:E
					R (read current totalizer volume reading)						T1R:<value> or T2R:<value> (in current EU)
					S (read current settings status)						T1S:Mode,StartFlow,LimitVolume,PowerOnDelay,AutoResetMode,AutoResetDelay Example: T1S:E,0.5,2045 2,10,0.5
					A Set Auto Reset mode		<value> [0-1] 0 – Disable 1 – Enable				T1A:0 - disabled Or T2A:1 - enabled
					I Set Auto Reset Interval delay		<value> [0-3600 sec.]				T1I:2 Or T2I:0
					B Restore Totalizer value from EE backup						T1B or T2B
					L Totalizer Lock status read / set		No Argument (read Lock status) <value> [0-1] Set Lock mode 0 – Unlock 1 – Lock				T1L:0 or T2L:0
					O Valve Over Limit Action		No Argument (read OL status) <value> [D or V]				T1O:D or T2O:D D - Valve Over Limit Dis'd V - Valve Over Limit Enab'd

COMMAND SYNTAX								
COMMAND NAME	DESCRIPTION	No.	Command	Argument 1	Argument 2	Argument 3	Argument 4	Response
Analog Output	Sets/Reads Instrument Analog Output settings and alarm status. Device Analog Output mode: Settings: 0 – 0-5 Vdc 1 – 0-10 Vdc 2 – 4-20 mA  Device Analog Output alarm status: N – No Alarm (normal operation). Y – Alarm is On (abnormal conditions are detected).	16	AO	M	No Argument (Returns Current Analog Output mode settings)  <Value> [0-2] Set new Analog Output mode settings			AOM:<Value> Example: AOM:0  AOM:<Value> Example: AOM:1
Analog Input	Sets/Reads Instrument Analog Input settings: Device Analog Input mode settings: 0 – 0-5 Vdc 1 – 0-10 Vdc 2 – 4-20 mA  Device Analog Input Damping: 0-100 are valid settings Default settings is 0: no averaging	17	AI	M	No Argument (Returns Current Analog Input mode settings)  <Value> [0-2] Set new Analog Input mode settings			AIM:<Value> Example: AIM:0  AIM:<Value> Example: AIM:1
				D	No Argument (Returns Current settings)			AID:0
					<Value> [0-100] Set new Analog Input damping settings			AID:0

COMMAND SYNTAX								
COMMAND NAME	DESCRIPTION	No.	Command	Argument 1	Argument 2	Argument 3	Argument 4	Response
Pulse Output	<p>Sets and controls action of the programmable Pulse Output circuitry.</p> <p>NOTE: Unit/Pulse value has to be entered in currently selected EU. EU has to be not time based it is recommended to set the unit/pulse value equal the device maximum flow in the same units per second equivalent. This will limit the pulse to no faster than one pulse every second.</p> <p>Example: Maximum flow rate: 600 liter/min (600 liter/min = 10 liters per second) If Unit/Pulse is set to 10 liters per pulse, the output will pulse once every second (F=1 Hz).</p> <p>Pulse active time in ms has to be at least twice less than pulse period (1/F). In this example any value between 50 and 500 ms will be acceptable.</p>	18	P	<p>U Set Units Per Pulse Parameter.</p> <p>T Set Pulse active Time in ms</p> <p>D (disable pulse output)*</p> <p>E (enable pulse output)</p> <p>Q (read current pulse output Queue value)</p> <p>F Set Flow Start value</p> <p>S (read setting status)</p>	<p>&lt;Value&gt; (Unit/Pulse) In current E.U. (example: 10 liter/pulse)</p> <p>&lt;value&gt; [25-3276 ms]</p>			<p>PU:&lt;value&gt; Example: PU:10</p> <p>PT:&lt;value&gt; Example: PT:100</p> <p>P:D</p> <p>P:E</p> <p>PQ:&lt;value&gt; (number of pulses in Queue)</p> <p>PF:1.0</p> <p>PS:Mode,FlowStart, Unit/ Pulse, Pulse Time Interval Example: PS:E,1.0,1.666,100</p>

COMMAND SYNTAX								
COMMAND NAME	DESCRIPTION	No.	Command	Argument 1	Argument 2	Argument 3	Argument 4	Response
Status LED	Read and set current Status LED mode: 0 – Normal 1 – F-Alarm & Totalizers only 2 – Alarm Events only 3 – Diagnostic Events 4 – UART interface events 5 – ModBus interface	19	S	No Argument (Returns Current Status LED mode)  <mode value> [0-5] Set new Status LED mode value				S: <mode value> Example: S:0  S: < mode value > Example: S:1
Mass Flow Units of measure	Set units of measure for mass flow rate and totalizer reading.  Note: The units of the totalizer output are mass flow units and not per unit time.  For users defined units: k-Factor value represents conversion value to L/min.  Time base argument: 0 - Seconds 1 - Minutes 2 - Hours 3 - Days  Density argument: 1 - Use density 0 - Do not use density	20	U	%FS* SuL/min SmL/sec Sml/min SmL/hr SL/sec SL/min SL/hr SL/day Sm3/min Sm3/hr Sm3/day Sf3/sec Sf3/min Sf3/hr Sf3/day gr/sec gr/min gr/hr gr/day kg/min kg/hr ay lb/min				U: %FS U: SuL/min U: SmL/sec U: Sml/min U: SmL/hr U: SL/sec U: SL/min U: SL/hr U: SL/day U: Sm3/min U: Sm3/hr U: Sm3/day U: Sf3/sec U: Sf3/min U: Sf3/hr U: Sf3/day U: gr/sec U: gr/min U: gr/hr U: gr/day U: kg/min U: kg/hr U: kg/day U: lb/min

COMMAND NAME	DESCRIPTION	No.	COMMAND SYNTAX					
			Command	Argument 1	Argument 2	Argument 3	Argument 4	Response
			lb/hr					U: lb/hr
			lb/day					U: lb/day
			oz/sec					U: oz/sec
			oz/min					U: oz/min
			NuL/min					U: NuL/min
			NmL/sec					U: NmL/sec
			NmL/min					U: NmL/min
			NmL/hr					U: NmL/hr
			NL/sec					U: NL/sec
			NL/min					U: NL/min
			NL/hr					U: NL/hr
			NL/day					U: NL/day
			Nm3/min					U: Nm3/min
			Nm3/hr					U: Nm3/hr
			Nm3/day					U: Nm3/day
			Nf3/sec					U: Nf3/sec
			Nf3/min					U: Nf3/min
			Nf3/hr					U: Nf3/hr
			Nf3/day					U: Nf3/day
			USER (user defined)	No Argument Set previously defined USER unit				U:USER
			USER (user defined) Change parameters of the user defined unit	<k-factor value> [>0.0]		<Time Base> 0- Second 1- Minute 2- Hour 3- Day	<Use Density> [0 or 1] 0 – No 1 – Yes	U:user, K:Factor, TimeBase,UseDensity Example: U:USER,1.5,1,0
			No Argument (status) Returns currently selected units.					U:<EU name> Example: U:Sml/min

		COMMAND SYNTAX						
COMMAND NAME	DESCRIPTION	No.	Command	Argument 1	Argument 2	Argument 3	Argument 4	Response
Volumetric Flow Units of measure	Set units of measure for volumetric flow rate	21	VU	%fS* uL/min ml/sec ml/min ml/hr L/sec L/min L/hr L/day m3/min m3/hr m3/day f3/sec f3/min f3/hr f3/day No Argument (status) Returns currently selected units				VU: %fS VU: uL/min VU: mL/sec VU: mL/min VU: mL/hr VU: L/sec VU: L/min VU: L/hr VU: L/day VU: m3/min VU: m3/hr VU: m3/day VU: f3/sec VU: f3/min VU: f3/hr VU: f3/day VU: mL/min
Calibration Settings	Sets/Reads Calibration related parameters. <b>Note: Factory set Standard conditions: 70.00 F and 14.6959 PSIA</b> <b>NOTE: Factory set normal conditions: 32.00 F and 14.6959 PSIA</b> Hours since last time unit was calibrated. NOTE: Has to be reset to zero each time power is removed after calibration. Power up pilot timer will be set to zero each time power is removed or instrument is reset.	22	C	S Read/Set Units Standard Conditions Temp [F]. Pressure [PSIA] T Read/Reset device main Calibration/Maintenance Timer N Read/Set Units Normal Conditions Temp [F]. Pressure [PSIA] P Read Time elapsed from Meter Power Up in hours	<Temp Value> [F] No Argument (Returns (timer values)) Z Reset Timer <Temp Value> [F] No Argument (Returns current STP values) No Argument	<Pres. Value> [PSIA]		CS:<Tvalue><Pvalue> e> Example: S:70.0,14.696 CS:<Tvalue><Pvalue> e> Example: S:70.0,14.696 CT:<valve> Example: CT:1024,2 CT:Z CN:<Tvalue><Pvalue> Example: N:32.0,14.696 CN:<Tvalue><Pvalue> Example: N:32.0,14.696 CP:148.7

COMMAND NAME	DESCRIPTION	No.	COMMAND SYNTAX					
			Command	Argument 1	Argument 2	Argument 3	Argument 4	Response
Signal Conditioner Settings	Sets/Reads Instrument Signal Conditioner Parameters  Note: the signal conditioner parameters were set on the factory to keep best performance. Do not change Signal Conditioner parameters unless instructed by factory technical representative!  NOTE: NLES parameter a1 must be more than a0. Similar NLES parameter D1 must be more than D0.	23	SC	M Read/Change Device Flow Signal Conditioner NLES mode E – Enabled* D – Disabled (No Conditioning)  R Flow Running Average Damping [1-255] 1-Disabled*  A AP Sensor Compensated signal conditioning NLES A0 and A1 parameters (do not change factory default setting unless instructed by tech support).  F AP Sensor Running Average Damping [1-255] samples 1-Disabled*  P Read/Change Device AP Signal Conditioner NLES mode E-Enabled* D-Disabled  D AP Sensor Compensated signal conditioning NLES D0 and D1 parameters (do not change factory default settings unless instructed by tech support).  T Temp Running Average Damping [1-255] 1-Disabled	<New Mode> [E/D]  No Argument (Returns current Mode)  <new value> [1-255]  No Argument (Returns current <a0_value> [0.01 - 0.99])  No Argument (Returns Current settings values)  <new value> [1-255]  No Argument (Returns Current settings value)  No Argument (Returns Current settings value)  <New Mode> [E/D]  <D0_value> [0.01 - 0.99]  No Argument (Returns Current settings values)  <new value> [1-255]  No Argument (Returns current setting value)			SCM:<value> Example: SCM:E  SCM:<value> Example: SCM:E  SCR:<value> Example: SCR:1  SCR:<value> Example: SCR:1  Example: SCA:0.20,0.80    SCF:<value>Example: SCF:4  SCF:<value> Example: SCF:4  Example: SCP:E  Example: SCP:E  SCD:<value> Example: SCD:0.20,0.80  SCD:<value> Example: SCD:0.20,0.80  SCT:<value>Example: SCT:10  SCT:<value> Example: SCT:10



COMMAND NAME		DESCRIPTION	No.	COMMAND SYNTAX					
COMMAND	NAME			Command	Argument 1	Argument 2	Argument 3	Argument 4	Response
OLED and Process Screens Settings**		Sets/Reads OLED related parameters**. Argument 1 = S Process Screens Mask register: 0x00FF -- screen mask (8 bits wide). Set bit -- Enable Screen Clear bit -- Disable Screen  See the list of Process Screens below.  0x01 -- M Flow Rate / Set Point 0x02 -- M Flow Rate / Totalizer#1 0x04 -- M Flow Rate / Totalizer#2 0x08 -- M Flow Rate / V Flow Rate 0x10 -- Configuration Info 0x40 -- PSP Status Info 0x80 -- Instr. Troubleshooting  NOTE: Screen #1 (0x01) cannot be disabled.  "L" command without any argument will return OLED status: Y-- Display installed N-- Display not installed  When Argument #2 is not submitted command returns current settings.	24	L	M LCD Process Screen Mode: S - Static D - Dynamic  C OLED Screen Saver Brightness Level: [1-128]  B OLED operational Brightness Level: [1-255]  O OLED Screen Saver Time Delay before activation: [1-36000] seconds  P OLED Screen Saver Mode 0 - Screen Saver Disabled 1 - Low Brightness mode 2 - Vertical Scrolling mode 3 - OLED off  T OLED Screen Saver Time interval in sec. (for dynamic mode)  S OLED Process Screens Mask register  D OLED Flow Reading decimal point precision: 0 - Normal 1 - Elevated (+1)	<New Value> S or D  No Argument (Returns Current Settings)  <new value> [1-128]  No Argument <new value> [1-255]  No Argument <new value> [1-36000]  No Argument <new mode> [0 - 3]  No Argument (Returns Current settings)  <New Value> [1-3600]  No Argument (Returns Current Settings)  <Value> 0x0001-0x003F (all 6 characters are required)  <new value> [0-1]			LM:<value> Example: LM:S  LM:<value> Example: LM:S  LC:<value> Example: LC:6  LC:<value> Example: LC:6  LB:<value> Example: LB:127  LB:<value> Example: LB:127  LO:<value> Example: LO:900  LO:<value> Example: LO:900  LP:<value> Example: LP:2  LP:<value> Example: LP:2  LT:<value> Example:LT:5  LT:<value> Example:T:5  Example: LS:0x3 (only first two screens are enabled 0x01 and 0x02) Example:LS:0x3F (all six screens are enabled)  LD:<value> ExampleLD:1  LD:<value> ExampleLD:1

COMMAND SYNTAX								
COMMAND NAME	DESCRIPTION	No.	Command	Argument 1	Argument 2	Argument 3	Argument 4	Response
Auto Zero	Sets/Reads Instrument Auto Zero related parameters <b>WARNING: make sure absolutely no flow through the instr. during SensorZero offset calibration!</b> <b>NOTE: For proper result instr. has to be connected to power for at least 15 minutes prior to Auto Zero calibration.</b> Auto Zero Status return parameters: <T value> - Current Tare value <ADC value> - Current ADC value AZ Status: N – Auto Zero Not Started I – Auto Zero In Process F – Auto Zero Failed D – Auto Zero is Done (Success) <b>WARNING: make sure instr. is open to atmosphere and absolutely no flow through the instr. during AP Sensor tare procedure! New AP Value must be taken from reference AP standard in PSIA!</b>	25	Z	A OLED Flow Running Average [0-25]  E OLED Flow reading Dead Band in % F.S. [0.0 - 0.99]  No Argument Returns OLED support status: Y or N  V Display current Zero Value  N Start Sensor Auto Zero calibration now. <b>NOTE: make sure absolutely no flow through the instrument!</b>  S Display Flow Auto Zero Status	<new value> [0-25] samples No Argument (Returns Current settings)  <new value> [0.0-0.99] %FS No Argument (Returns Current Settings)  No Argument  No Argument  No Argument  No Argument  No Argument  No Argument (Returns Current settings and status)  <New Value> [13.1 – 15.99] PSIA No Argument (Returns Current Set.) <New Values> [0-1] 0-Disabled, 1-Enabled			LA: <value> Example: LA:1  LA: <value> Example: LA:1  LE: <value> Example: LE:0.01  LE: <value> Example: LE:0.01  L: Y  ZV: < Value> Example: ZV:589  ZN <b>NOTE: For proper result instr must be connected to power for at least 15 minutes prior to Auto Zero Calibration.</b>  ZS: <1 value> ADC value> <AZ Status Ex: ZS:7492.70581,N  APZ: <OffsetValue> <ADC value> <TempCounts, <AZstatus>, Example: APZ:-00266 640002.839,N  ZA: <value> Example: ZA AB: <value> AB:0 AB: <value> AB:0

COMMAND SYNTAX								
COMMAND NAME	DESCRIPTION	No.	Command	Argument 1	Argument 2	Argument 3	Argument 4	Response
Pressure Units of Measure	Sets/Reads Pressure Units of Measure  %rFS units relative to the absolute pressure sensor full scale range.	26	PU	psiA				PU:PSIA
				barA				PU: barA
				mbarA				PU: mbarA
				hPaA				PU: hPaA
				kPaA				PU: kPaA
				MPaA				PU: MPaA
				atm				PU: atm
				g/cm2A				PU: g/cm2A
				kg/cmA				PU: kg/cmA
				inhgA				PU: inhgA
				mmHgA				PU: mmHgA
				cmH2OA				PU: cmH2OA
				inh2OA				PU: inh2OA
				TorrA				PU: TorrA
%FS				PU: %FS				
Temperature Units of Measure	Sets/Reads Temperature Units of Measure	27	TU	No Argument (Return Current settings)				PU:PSIA
				F				TU:F
				C				TU:C
				K				TU:K
				R				TU:R
				No Argument (Return Current settings)				TU:F
				D (Digital Interface)				M:A
Set Point Source	Sets/Reads Instrument Set Point Source parameter	28	M	A (Analog Interface)				M:D
				L (Loca Interface)				M:L
				P (Program Set Point)				M:P
				No Argument (Returns Current Settings)				M:D

COMMAND SYNTAX								
COMMAND NAME	DESCRIPTION	No.	Command	Argument 1	Argument 2	Argument 3	Argument 4	Response
Valve Control	Sets/Reads Instrument Valve and PID parameters settings.  NOTE: Do not change PID Loop Type parameter. Consult factory for more details regarding PID Loop Type.  0 - PD*  1 - PID  2 - PIDD  Submitting V command without value argument will return current parameter settings.  Valve Bias Current and Kmp parameters are bound to the specific valve. They were set on the factory according to your hardware to keep best performance. Do not change these parameters. Consult factory technical support for more info.	29	V	M Set Valve Mode Parameter.  L Set Valve PID loop type Parameter.  P Valve PID terms, Bias and Kmp coefficient	<Value> C - Closed A - Auto. O - Opened  <value> [0-2] 0 - Default [PD]  P Proportional Term  I Integral Term  D Derivative Term  B Valve Bias Current  M Valve Kmp coefficient  R Restore Factory default settings (consult factory)			VM:<value> Example: VM:A  VL<value> Example: VL:0  VPP:<value> VPP:0.08  VPI:<value> VPI:0.009  VPD:<value> VPD:0.16  VPB:<value> VPB:0.128  VPM:<value> VPM:3.125  VPR:0.08 0.009 0.16, 0.128, 3.125

COMMAND NAME	DESCRIPTION	No.	COMMAND SYNTAX					
			Command	Argument 1	Argument 2	Argument 3	Argument 4	Response
PID Auto Tune	<p>Sets/Reads Instrument PID Auto Tune parameters settings</p> <p>NOTE: Do not change PID Loop type parameter. Consult factory for more details regarding PID Auto Tune feature.</p> <p>PID Auto Tune Status:            I - In Process (currently active)            N - Not Started yet (not active)            D - Done (Success)            F - Failed</p> <p>Submitting AT command without value argument 2 will return current parameter settings.</p> <p><b>NOTE: DPC instrument Valve PID parameters were adjusted on the factory according to your order and they allow to handle most applications. Do not change PID parameters unless instructed by factory technical support representative!</b></p>	30	AT	<p>S Reads Auto Tune status: [I,N,D,F], [P_value],[L_value],[D_Valve]</p> <p>D Disable Auto Tune process (if active).</p> <p>V AT Valve Delay [1-99] x 100 ms</p> <p>O Auto Tune Oscillations Criteria</p> <p>&lt;value&gt; Start Auto Tune at specified Set Point value [2.0 - 100.0] %FS (valid values)</p>				<p>ATS:&lt;Status_value&gt;, P_value,I_value,D_value Example: ATS:D,0.108,0.054,0.2163</p> <p>ATD:D (if disabled) ATD:NR (if AT was not running)</p> <p>ATV:&lt;value&gt; ATV:3 (300 ms)</p> <p>ATO:&lt;value&gt; ATO:2.0</p> <p>AT:&lt;value&gt; AT:80.0</p>

COMMAND SYNTAX								
COMMAND NAME	DESCRIPTION	No.	Command	Argument 1	Argument 2	Argument 3	Argument 4	Response
Program Set Point	Sets/Reads Program Set Point parameters	31	PS	C Run / Stop Program Set Point  R - Run PSP S - Sto PSP  M Read/Change Device PSP Mode  L Read/Change Device PSP Loop Mode  P Read/Change Device PSP Step Parameters Read: only one argument is required. Change: all 3 arguments are required.  A Read/Change Device PSP Mask Register	No Argument (Ret. Current settings)  <value> R - Run S - Stop PSP  <value> [1-16] step number  <New Value> E or D  No Argument (Ret. Current settings)  <New Value> E or D  No Argument (Ret. Current settings)  <Step Number> [1-16]  <Step Number> [1-16]  No Argument (read current PSP Mask register)	<value> R-Run S - Stop PSP  <value> [0-86400 s.]  <Set Point> [0-100%FS]  <Value> 0x0000 - 0xFFFF Set new value NOTE: all 6 characters are required		PSC:R,11 (PSP is running and current step is 11)  PSC:<value> PSC:S (to stop PSP)  PSC:<value><value> PSC:5:R (to start from s. 5)  PSM:<value> Example: PSM:D  PSM:<value> Example: PSM:D  PSL:<value> Example: PSL:D  PSL:<value> Example: PSL:D  PSP:<step><SP><Time> Example: PSP02: 50.0,25  PSP:<step><SP><Time> Example: PSP02: 50,0,25  PSA:0xFFFF 0x00FF - screen mask (8 bits wide). Set bit - Step Enabled Clear bit - Step Disabled  PSA:0xFFFF

COMMAND SYNTAX								
COMMAND NAME	DESCRIPTION	No.	Command	Argument 1	Argument 2	Argument 3	Argument 4	Response
Mass Flow Set Point	Sets/Reads Mass Flow Set Point Value  NOTE: New Set Point value must not exceed 125% of instrument full scale range.	32	SP	No Argument (returns current settings)  <Value> (New SP Value in currently selected mass flow EU)				SP:<value> Example: SP:10.00  SP:<value> Example: SP:10.00
Local Set Point Options	Sets/Reads Local Set Point Option parameters  <b>WARNING: The "Saved Local Setpoint" parameter is saved in the instrument's EEPROM memory. To prevent EEPROM burning, avoid writing "Saved Local Setpoint" parameters more often than one time per minute.</b>	33	LS	<b>S</b> Local Set Point Saved Value  <b>M</b> Local and Digital Set Point Merge Mode. Argument 2: E- Enabled D- Disabled  <b>A</b> Local Set Point Auto Start Mode. Argument 2: E- Enabled D- Disabled	No Argument (returns current settings)  <Value> (New Value in currently selected mass EU)  <New Value> E or D			LSS:<value> Example: LSS:10.00  LSS:<value> Example: LSS:10  LSM:<value> Example: LSM:D  LSM:<value> Example: LSM:D  LSA:<value> Example: LSA:D  LSA:<value> Example: LSA:D

COMMAND SYNTAX								
COMMAND NAME	DESCRIPTION	No.	Command	Argument 1	Argument 2	Argument 3	Argument 4	Response
Compose Mixture	<p>Sets/Reads Gas Mixture Parameters</p> <p>Command submitted with all 4 arguments writes a new User Defined gas mixture (up to 5 Gas components) with the specified gas ratios, gas mixture name (up to 6 characters), and gas mixture number (200-219).</p> <p>It also can be used to update or delete a currently selected User Defined gas mixture.</p> <p>Argument#1 - Decimal string with new Gas Mixture index [200 - 219]</p> <p>Argument#2 - string with ';' delimited gas components indexes.</p> <p>Argument#3 - string with ',' delimited gas components ratios (number of components should be the same as in Argument#2)</p> <p>Argument#4 - string with new Gas mixture name (up to 6 characters long).</p>	34	CM	<p>No Argument (Checks how many Gas Mixtures currently saved in the EEPROM [0-20])</p> <p>D Delete last (highest index) Gas Mixture in the GM table</p> <p>&lt;Gas Mixture Index&gt; Check Name and number of components for particular Gas Mixture Index [200-219]</p> <p>&lt;Gas Mixture Index&gt; List all components gas indexes and ratios for particular Gas Mixture Index [200-219].</p> <p>&lt;New Gas Mixture Index&gt; Create New Gas Mixture. All 4 Arguments are required for this command.</p> <p><b>NOTE: number of Gas components indexes must be equal to number of ratios.</b></p> <p><b>NOTE: Sum of Gas components ratios must be equal to 100%.</b></p>				<p>CM:&lt;number of mixtures&gt; Example: CM:3</p> <p>CMD:&lt;index&gt; Example: CMD:202</p> <p>CM:&lt;index&gt;,&lt;comp#&gt;,&lt;name&gt; Example: CM:200.4,MyMix1</p> <p>CMC:&lt;index&gt;,&lt;comp#&gt;,&lt;G1&gt;,&lt;R1&gt;,&lt;G2&gt;,&lt;R2&gt;,&lt;Gn&gt;,&lt;Rn&gt; ... ,,&lt;mixture name&gt; Example: CMC:200.2,0.65.0.4,35.0,MyMix2</p> <p>CM:&lt;new mix index&gt;,&lt;name&gt;,&lt;number of components&gt; Example: CM:201,MyMix3.5</p>



COMMAND SYNTAX								
COMMAND NAME	DESCRIPTION	No.	Command	Argument 1	Argument 2	Argument 3	Argument 4	Response
ModBus ** Communication settings and address (optional)	Sets/Reads instrument ModBus Communication settings and address (optional)**  Diagnostic Command (argument D) returns following parameter:  MsgCtr –Message Counter SRSErrCtr – CRC Error SlaveMsgCtr – Slave Message Counter ORErrCtr – Overrun Error Counter	35	MB	B ModBus interface baud rate parameter:1200, 2400,4800,9600*, 19200, 38400,57600,115200  P ModBus interface Parity: 0 – None* 1 – ODD 2 – EVEN  S ModBus interface Stop Bits: [1 or 2*]  A ModBus slave device Address [1-247] Factory default address:11  D Diagnostic of Modbus state machine communication counters  R Reset ModBus communication Port and ModBus state machine.	No Argument (Return Current settings)  <Baud Rate Value >  No Argument (Return Current settings) <Parity Value >  No Argument (Return Current settings) <Stop Bit Value>  No Argument (Return Current settings) <AddressValue>  No Argument (Reports command receiving)			MBB:<Baud Rate Value>Example: MBB:9600  MBB:9600  MBP:<Parity Value> Example: MBP:0  MBP:0  MBS:<Stop Bits Value> Example: MBS:2  MBS:2  MBA:<Address Value> Example:MBA:11  MBA:11  MBD: MgCtr,SRSErrCtr, avelMsgCtr,ORErrCtr Example:MBD:1,0,0,0  MBR:Done
Read EEPROM Memory	Reads the value in the specified EEPROM	36	MR	0 to 413 (EEPROM Memory Index)				<memory value>
Write EEPROM Memory	Writes the specified value to the specified memory location. WARNING: Use Carefully, can cause unit to malfunction.(Note: Some addresses are write protected!) <b>WARNING: the instrument EEPROM parameters were set on the factory to keep best performance. Do not change EEPROM parameters unless instructed by factory technical support representative!</b>	37	MW	115 to 413 (EEPROM Memory Index) NOTE: EEPROM indexes 0-114 are read only!	<Value>			Command: MW,XXX,<Value> where: XXX= EEPROM Index Reply: Example: MW,101,3

## UART Error Codes:

- 1 – Command Not Supported or Back Door is not enabled.
- 2 – Wrong# of Arguments
- 3 – Address is Out of Range (MR or MW commands)
- 4 – Wrong# of the characters in the Argument
- 5 – Attempt to alter Write-Protected Area in the EEPROM
- 6 – Proper Command or Argument not found
- 7 – Wrong value of the Argument
- 8 – Manufacturer-specific information EE access KEY (wrong key or key is disabled)

## Alarm Events codes and bit position:

Code	Event Description	Bit position
0	FLOW_ALARM_HIGH	0x0001
1	FLOW_ALARM_LOW	0x0002
2	FLOW_ALARM_RANGE	0x0004
3	TOTAL1_HIT_LIMIT	0x0008
4	TOTAL2_HIT_LIMIT	0x0010
5	PRES_ALARM_HIGH	0x0020
6	PRES_ALARM_LOW	0x0040
7	PRES_ALARM_RANGE	0x0080
8	TEMP_ALARM_HIGH	0x0100
9	TEMP_ALARM_LOW	0x0200
A	TEMP_ALARM_RANGE	0x0400
B	PULSE_OUT_QUEUE	0x0800
C	PASSWORD_EVENT	0x1000
D	POWER_ON_EVENT	0x2000

## Diagnostic Events codes and bit position:

Code	Event Description	Bit position
0	CPU_TEMP_HIGH	0x0001
1	DP EE INIT ERROR	0x0002
2	AP EE INIT ERROR	0x0004
3	VREF_OUT_OF_RANGE	0x0080
4	FLOW ABOVE LIMIT	0x0010
5	AP OUT OF RANGE	0x0020
6	G TEMP OUT OF RANGE	0x0040
7	ANALOG OUT ALARM	0x0080
8	SER COMM FAILURE	0x0100
9	MB COMM FAILURE	0x0200
A	EEPROM FAILURE	0x0400
B	AUTOZERO FAILURE	0x0800
C	AP TARE FAILURE	0x1000
D	DP PRESSURE INVALID	0x2000
E	AP PRESSURE INVALID	0x4000
F	FATAL_ERROR	0x8000

## **10. TROUBLESHOOTING**

### **10.1 Common Conditions**

Your DPC Mass Flow Controller was thoroughly checked at numerous quality control points during and after manufacturing and assembly operations. It was calibrated according to your desired flow and pressure conditions for a given gas or mixture of gases.

It was carefully packed to prevent damage during shipment. Should you feel that the instrument is not functioning properly, please check first for these common conditions:

- Are all cables connected correctly?
- Are there any leaks in the installation?
- Is the power supply correctly selected according to requirements?
- When several controllers are used, a power supply with appropriate current rating should be selected.
- Were the connector pinouts matched properly?
- When interchanging with other manufacturers' equipment, cables and connectors must be carefully wired for correct pin configurations. Check these.
- Is the pressure differential across the instrument sufficient?

Also check the Troubleshooting Guide provided in Section 10.2.

## 10.2 Troubleshooting Guide

**TABLE XXIII: TROUBLESHOOTING GUIDE**

NO.	INDICATION	LIKELY REASON	SOLUTION
1	No zero reading, with no flow condition.	Flow Tare procedure was not performed properly.	Perform Auto Zero Procedure (see section 6.4.16 "Sensor Zero Calibration").
2	Status LED indicator and OLED Display remain blank when unit is powered up. No response (when SP and flow is introduced) from analog outputs 0-5Vdc or 4-20 mA.	Power supply is bad or polarity is reversed.	Measure voltage on pins 7 (+) and 8 (-) of the 8-pin MinDIN connector. If voltage is out of specified range, then replace power supply with a new one. If polarity is reversed (reading is negative), make correct connection.
		PC board is defective.	Return DPC to factory for repair.
3	OLED Display reading and/or analog output 0-5Vdc signal fluctuates in wide range during flow control.	Output 0-5Vdc signal (pins 6 [+] and 4 [-] of the MiniDIN connector) is shorted on the GND or overloaded.	Check external connections to pin 6 (+) and 4 (-), of the MiniDIN connector. Make sure the load resistance is more than 3000 $\Omega$ .
4	OLED Display reading does correspond to the correct flow range, but 0-5Vdc output signal does not change (always the same reading or around zero).	Output 0-5Vdc circuitry is burned out or damaged.	Return DPC to factory for repair.
		Analog flow output scale and offset variable are corrupted.	Restore original EEPROM scale and offset variable or perform analog output recalibration (see Section 6.4.15.7).
5	OLED Display reading and 0-5Vdc output voltage do correspond to the correct flow range, but 4-20 mA output signal does not change (always the same or reading around 4.0 mA).	External loop is open or load resistance more than 550 $\Omega$ .	Check external connections to pins 6 (+) and 4 (-) of the D-connector MiniDIN. Make sure the loop resistance is less than 550 $\Omega$ .
		Output 4-20 mA circuitry is burned out or damaged.	Return DPC to factory for repair.
6	Calibration is off (more than $\pm 0.5\%$ F.S.).	DPC has initial zero shift.	Shut off the flow of gas into the DPC; ensure gas source is disconnected and no seepage or leak occurs into the controller from either port). Wait for 1 min. with no flow condition and perform Auto Zero calibration Procedure (see Section 6.4.16 "Zero Calibration").

NO.	INDICATION	LIKELY REASON	SOLUTION
7	OLED reading for Mass Flow, Volumetric Flow, Gas Pressure or Gas Temperature is flashing.	Measured parameter exceeds the range of the corresponding sensor in the instrument.	Reduce the value of the flashing parameter within specified limits. For example, reduce Mass Flow rate below 133% of instrument full scale range. NOTE: When at least one parameter is flashing on the display, the value of this parameter and mass flow reading cannot be considered accurate.
		PC board or sensor is defective.	Return DPC to factory for repair.
8	Gas is connected to the inlet of the DPC, but there is no flow.	The instrument valve is in "Closed" mode.	Check "Valve Mode" parameter, it has to be set to "Auto" to be able execute requested set point.
		The Set Point Source is different or Set Point value is zero.	Check that Set Point Source parameter is properly selected, make sure SP value more than 0.
9	The error between DPC mass flow reading and another meter connected in series is more than combined accuracy for both instruments.	1. Instruments may be configured to measure different Gas.	Make sure there is enough differential pressure to execute desired flow rate (See Table II "Instrument Pressure Drop").
		2. Other meter mass flow may have different standard conditions settings.	Decrease voltage drop in the signal cable by properly selecting AWG gage based on cable distance (use at least 22 AWG for more than 100 ft).
		3. There is leakage in the pipe between the DPC and other meter.	3. Check installation connections for leakage.
10	The Mass Flow reading is below the Set Point value.	The differential pressure across the instrument is less than maximum pressure drop for corresponding flow range.	Make sure there is enough differential pressure to execute desired flow rate (See Table II "Instrument Pressure Drop").
		The set point is applied via analog interface and connection line is too long or cable wires gage is too high (high resistance wires)	Decrease voltage drop in the signal cable by properly selecting AWG gage based on cable distance (use at least 22 AWG for more than 100 ft).

NO.	INDICATION	LIKELY REASON	SOLUTION
11	Flow reading is slow to react to the set point or unstable (jumps up and down).	The instrument valve PID loop parameters were changed or not properly set.	Use “Restore Valve PID” menu selection to restore factory original PID parameters settings (see Section 6.4.4).
		The differential pressure across instrument is too high.	Reduce differential pressure across instrument inlet and outlet ports (see Section 5 “Specification” for instrument pressure limits).
12	The Digital RS-232 or RS-485 i communication interface is not responding on commands from Host PC.	The communication interface wiring is not correct.	Make sure the communication port is wired according to selected interface type (see Section 3.4 and Figure 3).
		<ol style="list-style-type: none"> <li>1. The selected Host PC communication port is not active or has different number.</li> <li>2. The instrument has different RS-485 address (applicable for RS-485 interface only).</li> </ol>	Make sure proper communication port is selected and port settings are correct. For RS-485 instruments make sure that each device on the RS-485 bus has unique address.

### **10.3 Technical Assistance**

Aalborg Instruments will provide technical assistance over the phone to qualified repair personnel. Please call our Technical Assistance at 1-845-770-3000. Be sure to have your instrument's Serial Number and Model Number ready for reference when you call.

# APPENDIX I: COMPONENT DIAGRAM

## Top Component Side

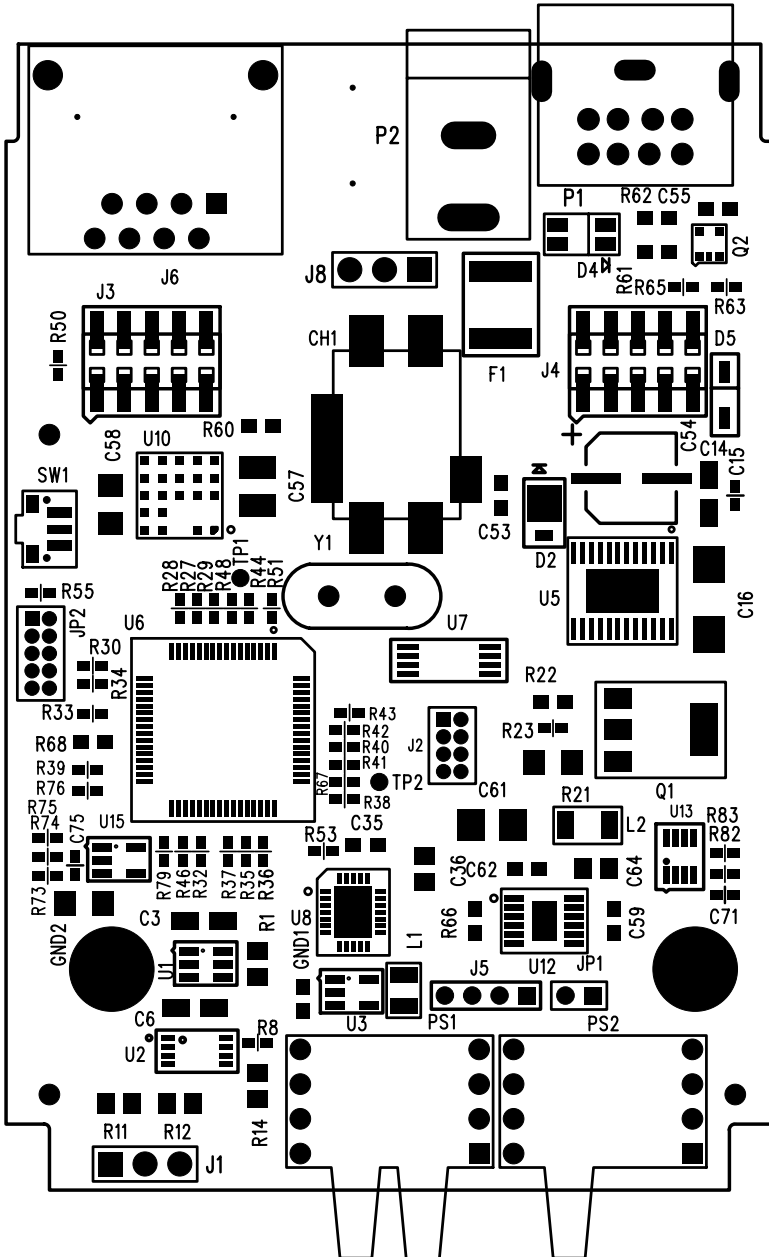



# Bottom Component Side

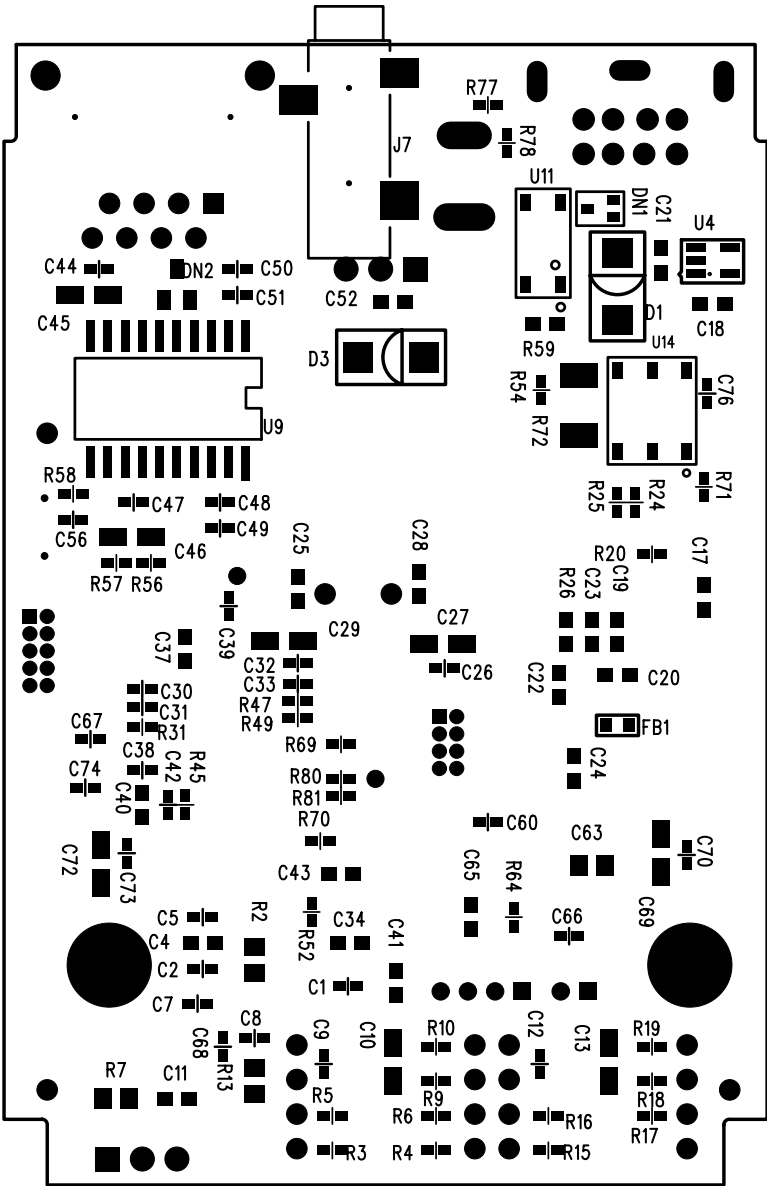

## APPENDIX II: DIMENSIONAL DRAWINGS

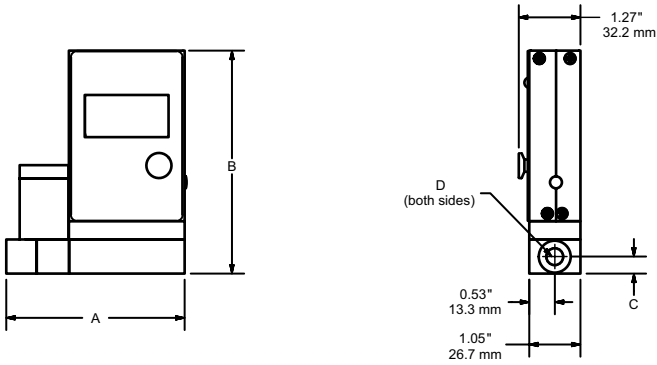

### DPC 04/14 and DPC07/17

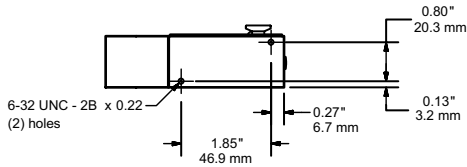

MODEL	A	B	C	D
DPC04 / 07	3.68" (93.4 mm)	4.58" (116.2 mm)	0.34" (8.5 mm)	10-32 UNF
DPC14	3.85" (97.7 mm)	4.84" (122.8 mm)	0.42" (10.7 mm)	1/4 NPT
DPC17	3.66" (92.9 mm)	4.40" (111.8 mm)	0.35" (8.9 mm)	1/8 NPT

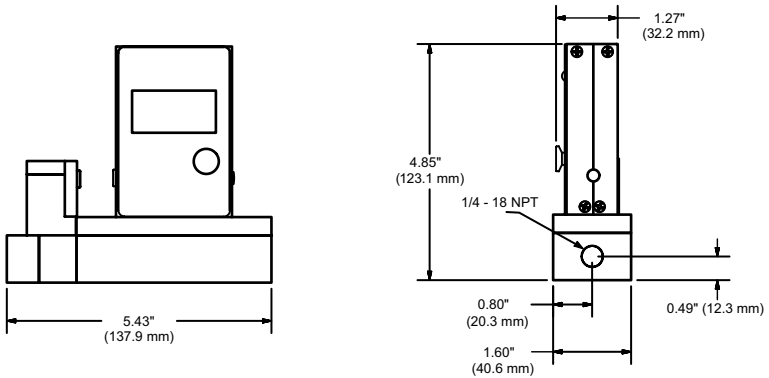

8-32 UNC - 2B x 0.30

### DPC 37 and DPC 47

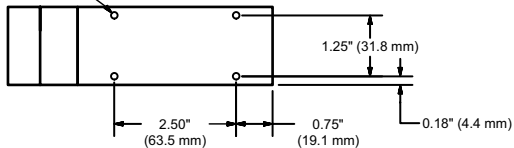

NOTE: Aalborg® reserves the right to change designs and dimensions at its sole discretion at any time without notice. For certified dimensions please contact Aalborg®.

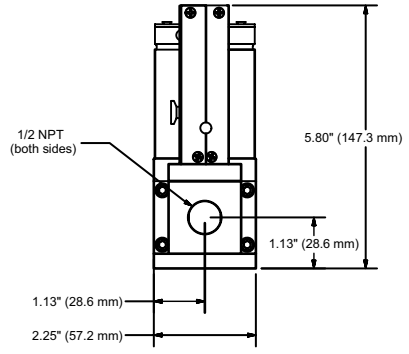
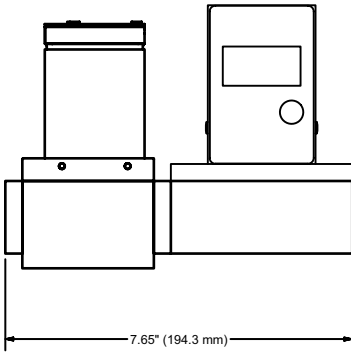

**DPC 57**

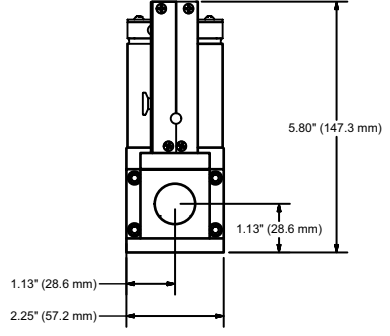
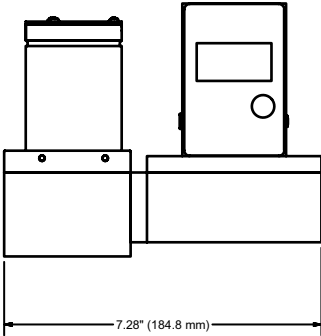
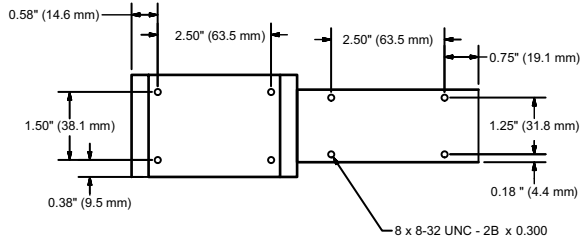

**DPC 67  
and 77**

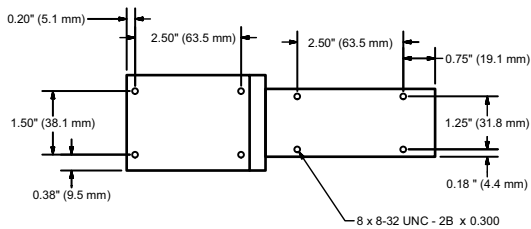

NOTE: Aalborg® reserves the right to change designs and dimensions at its sole discretion at any time without notice. For certified dimensions please contact Aalborg®.

## **APPENDIX III WARRANTY**

**(Be sure to follow Return Procedures as outlined in Section 1.3)**

### **WARRANTY**

Aalborg® Mass Flow Systems are warranted against parts and workmanship for a period of one year from the date of purchase. Calibrations are warranted for up to six months after date of purchase, provided calibration seals have not been tampered with. It is assumed that equipment selected by the customer is constructed of materials compatible with gases used. Proper selection is the responsibility of the customer. It is understood that gases under pressure present inherent hazards to the user and to equipment, and it is deemed the responsibility of the customer that only operators with basic knowledge of the equipment and its limitations are permitted to control and operate the equipment covered by this warranty. Anything to the contrary will automatically void the liability of Aalborg and the provisions of this warranty. Defective products will be repaired or replaced solely at the discretion of Aalborg at no charge. Shipping charges are borne by the customer. This warranty is void if the equipment is damaged by accident or misuse, or has been repaired or modified by anyone other than Aalborg or factory authorized service facility. This warranty defines the obligation of Aalborg and no other warranties expressed or implied are recognized.

## APPENDIX IV: INDEX OF FIGURES

Figure #	Title	Page
1	DPC Mass Flow Controller shown with an upstream valve configuration	4
2	DPC Mass Flow Controller shown with a downstream valve configuration	4
3	DPC 8-pin Mini-DIN Connector Configuration	6
4	DPC RS-232 Communication Interface Connections	10
5	DPC RS-485 Communication Interface Connections	11
6	DPC First Banner Screen	18
7	DPC Firmware and Communication Interface Information Screen	18
8	DPC Initial Process Information	18
9	Joystick	19
10	DPC Process Information Screens	21
11	Program Protection Screen	22
12	Program Protection Password Screen	22
13	Change PP Password Screen	23
14	PP Password Change Confirmation Screen	24
15	General Settings and Valve Parameters Menus	24
16	Set Point Source Menu Selections	24
17	Changing Local Set Point value	25
18	Valve Mode Menu Selections	25
19	DPC Upper Levels Menu Structures	32
20	Selecting Gas Group	33
21	Add Mixture Menu Selection	39
22	Assigning a Name to the Mixture	40
23	Add Gas Component and Ratio	40
24	Selecting Gas Component	40
25	G1 Component with Selected Gas	41
26	G1 Component with Highlighted Ratio Values	41
27	Mixture with 4 Components Ready to be Saved	42
28	Mixture Saved Confirmation Message	42
29	"User-Defined Mixture" Menu Selection with new MyMix1 Mixture	43
30	"Edit Mixture" Menu Selection	43
31	Reset Totalizer Screen	50
32	Totalizer Reset Confirmation	50

**APPENDIX IV: INDEX OF FIGURES  
(continued)**

<b>Figure #</b>	<b>Title</b>	<b>Page</b>
33	PI Screen Configuration	54
34	PSP Steps Mask Configuration	65
35	PSP Steps Settings	65
36	Instrument PI Screen #7 with PSP parameters	66
37	Start Sensor Auto Zero	67
38	Sensor Auto Zero "On" Confirmation	67
39	Sensor Auto Zero Completed	68
40	Start AP (Absolute Pressure) Sensor Tare	69
41	Entering Ambient Pressure from Reference Standard	69
42	Alarm Events Register (with no alarms)	71
43	Alarm Events Register (with two active events)	71
44	Alarm Events Mask Register	72
45	Alarm Events Latch Register	72
46	Resetting Alarm Events Register	73
47	Alarm Event Register Reset Confirmation	73
48	Diagnostic Events Status Register (no active events)	75
49	Diagnostic Events Status Register (two active events)	75
50	Diagnostic Events Mask Register	75
51	Diagnostic Events Latch Register	76
52	Resetting Diagnostic Events Register	77
53	Confirmation of Diagnostic Events Register Reset	77
54	Pressure Sensors ADC Diagnostic	77
55	Temperature Sensors Diagnostics	78
56	Analog Output and PO Queue Diagnostic	78
57	Solenoid Valve Parameters Diagnostic	79
58	Reference Voltage and DSP Calculation Diagnostic	79
59	DPC and Multi-Function Push-Buston Access Hole	80

## APPENDIX V: INDEX OF TABLES

Table #	Title	Page
I	8-Pin Designations and Notes	5
II	DPC Flow Ranges	15
III	DPC Accessories	15
IV	Pressure Drops	17
V	Approximate Weights	17
VI	List of Supported Mass Flow Units of Measure	28
VII	List of Supported Volumetric Units of Measure	30
VIII	List of Supported Absolute Pressure Units of Measure	30
IX	List of Supported Temperature Units of Measure	31
X	Standard Pure Non-Corrosive Gases	34
XI	Bioreactor Gases	35
XII	Breathing Gases	36
XIII	Chromatography Gases	36
XIV	Fuel Gases	37
XV	Laser Gases	38
XVI	O2 Concentrator Gases	38
XVII	Stack Gases	38
XVIII	Welding Gases	39
XIX	Alarm Events Register	70
XX	Diagnostic Events Register	74
XXI	LED Indications using the Multi-Function Push-Button During Normal Running Mode	81
XXII	Aalborg DPC ASCII Software Interface Commands	85
XXIII	Troubleshooting Guide	112

## Products Manufactured By Aalborg

### ROTAMETERS

#### Single Tube

Aluminum / Brass / Stainless • Interchangeable Glass Flow Tubes • Optional Valves

#### Multiple Tube

Two to Six Channels • Aluminum or Stainless

#### PTFE Single and Multiple Tube

Chemically Inert • 1 to 4 Channels • Interchangeable Glass Flow tubes

#### PTFE - PFA

Chemically Inert • Low to Medium Flow of Corrosive Liquids with PFA Flow Tube

#### Kits

Aluminum / Stainless / PTFE • Including Five Glass Flow Tubes and a Set of Floats

#### Gas Proportioners

Aluminum / Stainless • Used for Blending Two or Three Gases

#### Medium Range

Glass Safety Shield • Dual Air and Water Scale

#### Optical Sensor Switch

Non-Invasive Means for Detection of a High or Low Flow

#### High Flow Industrial Stainless Steel Flow Meters

Heavy Duty Stainless Steel • Direct Reading Air and Water Scales

### VALVES

#### Barstock

Brass or Stainless • Standard or High Precision

#### PTFE

Chemically Inert • Needle or Metering

#### Proportionating Solenoid

Stainless • For Controlling Gas or Liquid Flow

Pulse width Modulated

**SMV • Stepping Motor Valve**

### PERISTALTIC PUMPS

**Fixed RPM Pumps**

**Pump Heads**

**Tubing Pumps**

**Variable Speeds**

**Dispensing Pumps**

**Flexible Tubings**

### ELECTRONIC METERS & CONTROLLERS

#### Low Cost Mass Flow Meters

Aluminum or Stainless • With or Without LCD Readout

#### Low Cost Mass Flow Controllers

Aluminum or Stainless • With or Without LCD Readout

#### Mass Flow Controllers

Stainless • One to Four Channel Systems

#### Digital Mass Flow Controllers

Auto Zero • Totalizer • Alarms = Built in RS485

#### Multi-Parameter Digital Mass Flow Meters

Displays Flow Pressure and Temperature

#### Paddle Wheel Meters

For Liquids • Optional Temperature Measurements

#### Vortex In-Line and Insertion Flow Meters

Steam / Liquid and Gas Service

#### Smart Rate / Totalizer / Signal Conditioner

LCD Keypad • RS232 / 485 • Pulse Output • Alarms